

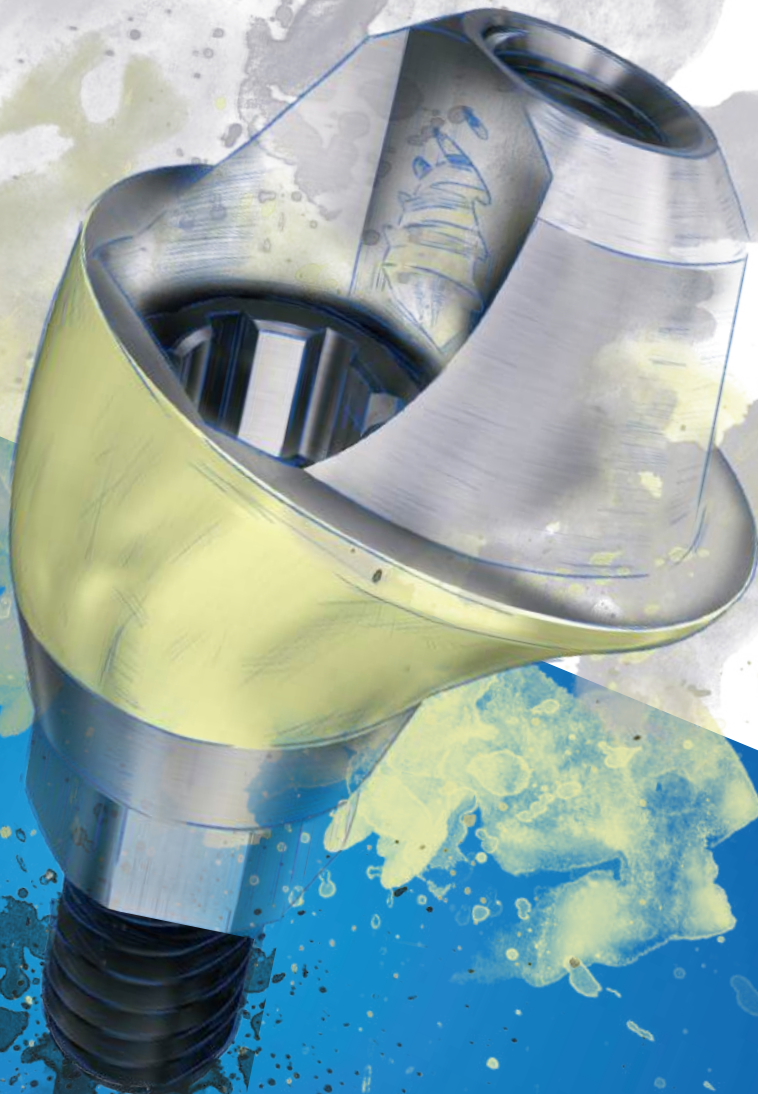

DESS

> DENTAL SMART SOLUTIONS

Catalogue 2024



PRODUCT LIST

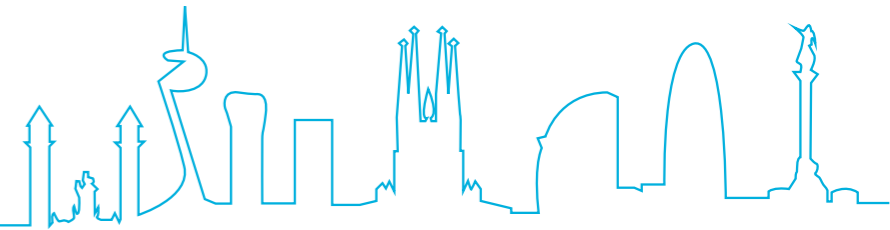

 **NOBELACTIVE® & NOBELREPLACE® CC**
ACTIVE HEX 04

 **NOBEL REPLACE SELECT™**
TRI-LOBE 10

 **NOBEL BRÅNEMARK®**
EXTERNAL HEX UNIVERSAL 16

 **3i OSSEOTITE®**
EXTERNAL HEX USA 22

 **3i CERTAIN®**
INTERNAL HEX "CLICK" 28

 **STRAUMANN® SOFT TISSUE LEVEL & synOcta®**
OCTAGON 34

 **STRAUMANN® BONE LEVEL**
CONICAL BL 40

 **STRAUMANN® BLX**
CONICAL BLX 46

 **NEODENT® GRAND MORSE**
NEO GM 50

 **ZIMMER SCREW-VENT®**
INTERNAL HEX USA 54

 **ASTRA TECH IMPLANT SYSTEM™ EV**
CONIC EVO 60

 **ASTRA TECH OSSEOSPEED™**
INTERNAL HEX CONIC 66

 **DENTSPLY FRIADENT XIVE®**
INTERNAL HEX FD 72

 **DENTSPLY ANKYLOS® C/X**
INTERNAL ANK 78

 **OSSTEM® TS**
CONIC OSS 82

 **CAMLOG®**
INTERNAL CAM 86

 **CONELOG®**
INTERNAL CON 90

 **BIOHORIZONS® INTERNAL**
INTERNAL HEX BH 94

 **BIOHORIZONS® EXTERNAL**
EXTERNAL HEX BH 98

 **MIS® SEVEN**
INTERNAL HEX MI 102

 **MIS® C1**
CONIC MC 108

 **MIS® V3**
CONIC MV 110

 **MEGAGEN AnyRidge®**
CONIC ANYR 112

 **Anthogyr AXIOM® BL**
CONIC AXIO 116

 **MEDENTIS ICX®**
CONIC IC 118

 **GLOBALD IN-KONE®**
CONIC INK 122

 **DENTIUM SUPERLINE™ & IMPLANTIUM®**
CONIC DENT 124

 **BEGO SEMADOS®**
INTERNAL SEM 128

 **BIOTECH KONTAKT®**
CONIC BIO 130

 **BTI®**
INTERNAL BT 132

 **PHIBO® TSH®**
EXTERNAL HEX PH 134

 **MULTI-UNIT CONNECTION** 136

 **OVERDENTURE SYSTEMS**
DESSLoc® & DESS CLEAN FIT 140

 **HOLDERS & BLOCKS** 144

 **TOOLS** 146

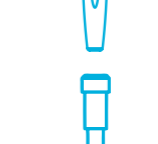
 **CLINICAL SCREWS FOR STRUCTURES & RECOMMENDED TORQUE** 150

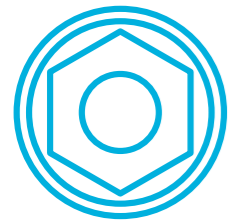

ACTIVE HEX

compatible with
NobelActive® / Replace® CC

○ non-engaging

⬡ engaging





HEALING ABUTMENT	3.0	NP	RP	WP
	3.0	3.5	4.3/5.0	5.5
GH 3,0mm ^A	20.068/3*	20.039/3	20.040/3	20.069/3*
GH 3,0mm ^B		20.047/3	20.048/3	20.070/3*
GH 4,0mm ^A	20.068/4*	20.039/4	20.040/4	20.069/4*
GH 4,0mm ^B		20.047/4	20.048/4	20.070/4*
GH 5,0mm ^A	20.068/5*	20.039/5	20.040/5	20.069/5*
GH 5,0mm ^B		20.047/5	20.048/5	20.070/5*

^A for single crown restoration ^B for bridges and structures restoration

SCAN ABUTMENTS



	3.0	NP	RP	WP
	52.068	52.041	52.042	52.069

 EXTISA extender for 52.xxx.  52.xxx includes manual tool DTPEIPEEK.

TRANSFER



	3.0	NP	RP	WP
	17.068	17.044	17.045	17.069

Transfers include two screws (for open and closed tray).



Platform Colour Coded

DIGITAL ANALOGUE

Retention screw Hex 1,27 mm*

*Other retention screws available, see page 159



Platform Colour Coded

ANALOGUE

	3.0	NP	RP	WP
	3.0	3.5	4.3/5.0	5.5
	14.068/D	14.041/D	14.042/D	14.069/D
10 Pack.	14.068	14.041	14.042	14.069
		14.041-P10	14.042-P10	14.069-P10



TEMPORARY ABUTMENT

	3.0	NP	RP	WP
○	24.068*	24.041	24.042	24.069*
⬡	25.068*	25.041	25.042	25.069*



DESSLoc®

GH 1,0mm	88.039/1	88.040/1
GH 2,0mm	88.039/2	88.040/2
GH 3,0mm	88.039/3	88.040/3
GH 4,0mm	88.039/4	88.040/4



MULTI-UNIT ABUTMENTS

		3.0	NP	RP	WP
		3.0	3.5	4.3/5.0	5.5
GH 1,5mm	0°		40.007/1	40.008/1	
GH 2,5mm	0°		40.007/2	40.008/2	
GH 3,5mm	0°		40.007/3	40.008/3	
GH 4,5mm	0°			40.008/4	
GH 2,5mm	17°		41.707/2	41.708/2	
GH 3,5mm	17°		41.707/3	41.708/3	
GH 3,5mm	30°		43.007/3	43.008/3	
GH 4,5mm	30°		43.007/4	43.008/4	

4.8
MULTI-UNIT PLATFORM

NEW
MUA+







GH 1,5mm	0°		42.404/1	42.405/1	
GH 2,5mm	0°		42.404/2	42.405/2	
GH 3,5mm	0°		42.404/3	42.405/3	
GH 4,5mm	0°			42.405/4	
GH 2,5mm	17°		46.404/2	46.405/2	
GH 3,5mm	17°		46.404/3	46.405/3	
GH 3,5mm	30°		47.404/3	47.405/3	
GH 4,5mm	30°		47.404/4	47.405/4	

4.8
MULTI-UNIT PLATFORM



TI-BASE

		3.0	NP	RP	WP
		3.0	3.5	4.3/5.0	5.5
GH 1,2mm	○			15.042	
GH 1,5mm	○	 15.468	 15.441		15.069
GH 2,0mm	○			15.042/2	
GH 3,0mm	○			15.342	
GH 1,2mm	⬡			16.042	
GH 1,5mm	⬡	 16.468	 16.441		16.069
GH 2,0mm	⬡			16.042/2	
GH 3,0mm	⬡			16.342	

TI-BASE CASTABLES



5 Pack.	○			32.001-P5	32.001-P5
5 Pack.	⬡			33.001-P5	33.001-P5

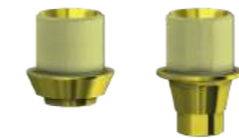

ANGLEBase®

○		36.041	36.042
⬡		37.041	37.042

PLASTIC SLEEVES FOR ANGLEBase®



5 Pack.	0°	33.100-P5	33.100-P5
5 Pack.	10°	33.101-P5	33.101-P5
5 Pack.	20°	33.102-P5	33.102-P5

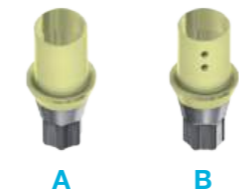





ELLIPTIBase®

A corner	⬡	56.068
B flat	⬡	57.068



C-Base®

		3.0	NP	RP	WP
		3.0	3.5	4.3/5.0	5.5
GH 0,8mm			58.041	58.042	
GH 3,0mm			58.041/3	58.042/3	
GH 0,8mm			59.041	59.042	
GH 3,0mm			59.041/3	59.042/3	

Includes screw, same as standard screw.

Libraries available for EXOCAD & 3Shape.

**Torx® Screw
ANGLEBase® & ELLIPTIBase® & ASC BLANK**



<i>(replacement screw)</i>	19.468	19.441	19.442	
<i>Recommended torque</i>	<i>15 Ncm</i>	<i>35 Ncm</i>	<i>35 Ncm</i>	

Torx® BALL SCREWDRIVER



	20mm	24mm	30mm	35mm
	DT20TB06	DT24TB06	DT30TB06	DT35TB06

ABUTMENTS



0°		13.041	13.042	
15°		22.041*	22.042*	
25°			23.042*	

SCREW UG



	19.068	19.027	19.030	19.030
10 Pack.		19.027-P10	19.030-P10	19.030-P10
DLC	19.268*	19.227	19.230	19.230
TiN	19.668*	19.627*	19.630*	19.630*

Recommended torque *15 Ncm* *35 Ncm* *35 Ncm* *35 Ncm*







PRE-MILLED BLANK

		3.0	NP	RP	WP
		3.0	3.5	4.3/5.0	5.5
Ø 10mm	Ti	61.068	61.041	61.042	61.069
Ø 14mm	Ti		62.041	62.042	62.069
Ø 14mm	CoCr		71.041		71.069



A **B**

**NEW
ASC BLANK**

Ø 10mm	Ti	A corner		61.349*	
Ø 10mm	Ti	B flat		71.349*	
Ø 14mm	Ti	A corner			61.341* 61.342*
Ø 14mm	Ti	B flat			71.341* 71.342*

CoCr BASE



				30.041	30.042
				31.041	31.042

CASTABLE



				28.041	28.042
				29.041	29.042



TRI-LOBE

compatible with
NobelReplace Select™

○ non-engaging

◁ engaging



HEALING ABUTMENT

	NP	RP	WP	6.0
	NP/3.5	RP/4.3	WP/5.0	6.0
GH 3,0mm	20.004/3	20.005/3	20.006/3	
GH 4,0mm	20.004/4	20.005/4	20.006/4	
GH 5,0mm	20.004/5	20.005/5	20.006/5	



SCAN ABUTMENTS



	52.004	52.005	52.006	52.097
--	--------	--------	--------	--------



EXTISA extender for 52.xxx.



52.xxx includes manual tool DTPEIPEEK.



TRANSFER

	17.004	17.005	17.006	17.097
--	--------	--------	--------	--------

Transfers include two screws (for open and closed tray).



Platform Colour Coded

DIGITAL ANALOGUE

Retention screw Hex 1,27 mm*	14.004/D	14.005/D	14.006/D	14.097/D
------------------------------	----------	----------	----------	----------

*Other retention screws available, see page 159



Platform Colour Coded

ANALOGUE

	NP	RP	WP	6.0
	NP/3.5	RP/4.3	WP/5.0	6.0
	14.004	14.005	14.006	14.097
10 Pack.	14.004-P10	14.005-P10		



TEMPORARY ABUTMENT

○	24.004	24.005	24.006
◁	25.004	25.005	25.006



DESSLoc®

GH 1,0mm	88.004/1	88.005/1
GH 2,0mm	88.004/2	88.005/2
GH 3,0mm	88.004/3	88.005/3
GH 4,0mm	88.004/4	88.005/4



MULTI-UNIT ABUTMENTS			NP	RP	WP	6.0
			NP/3.5	RP/4.3	WP/5.0	6.0
GH 1,0mm	0°	○	40.004/1	40.005/1	40.006/1	
GH 2,0mm	0°	○	40.004/2	40.005/2	40.006/2	
GH 3,0mm	0°	○	40.004/3	40.005/3	40.006/3	
GH 4,0mm	0°	○		40.005/4		
GH 5,0mm	0°	○		40.005/5		
GH 2,0mm	17°	◁	41.704/2*	41.705/2*		
GH 3,0mm	17°	◁	41.704/3*	41.705/3*		
GH 4,0mm	17°	◁		41.705/4*		
GH 4,0mm	30°	◁		43.005/4*		
GH 5,0mm	30°	◁		43.005/5*		
GH 5,0mm	30°	○		43.005/5R*		

4.8
MULTI-UNIT PLATFORM



TI-BASE						
GH 0,3mm		○	15.004	15.005	15.006	15.097
GH 1,5mm		○	15.204	15.205	15.206	
GH 3,0mm		○	15.304	15.305	15.306	
GH 0,3mm		◁	16.004	16.005	16.006	16.097
GH 1,5mm		◁	16.204	16.205		
GH 3,0mm		◁	16.304	16.305		



TI-BASE CASTABLES						
5 Pack.		○	32.001-P5	32.001-P5	32.001-P5	32.001-P5
5 Pack.		◁	33.001-P5	33.001-P5	33.001-P5	33.001-P5



ANGLEBase®		NP	RP	WP	6.0
		NP/3.5	RP/4.3	WP/5.0	6.0
	○	36.004	36.005	36.006	
	◁	37.004	37.005	37.006	



PLASTIC SLEEVES FOR ANGLEBase®						
5 Pack.	0°	33.100-P5	33.100-P5	33.100-P5		
5 Pack.	10°	33.101-P5	33.101-P5	33.101-P5		
5 Pack.	20°	33.102-P5	33.102-P5	33.102-P5		



C-Base®						
GH 0,4mm		○	58.004		58.006	58.097
GH 0,5mm		○		58.005		
GH 1,5mm		○	58.004/2	58.005/2	58.006/2	
GH 3,0mm		○	58.004/3	58.005/3	58.006/3	
GH 0,4mm		◁	59.004		59.006	59.097
GH 0,5mm		◁		59.005		
GH 1,5mm		◁	59.004/2	59.005/2	59.006/2	
GH 3,0mm		◁	59.004/3	59.005/3	59.006/3	

Includes screw, same as standard screw.

Libraries available for EXOCAD & 3Shape.



Torx® Screw ANGLEBase®				
(replacement screw)		19.404	19.405	19.405
Recommended torque		35 Ncm	35 Ncm	35 Ncm



Torx® BALL SCREWDRIVER				
	20mm	24mm	30mm	35mm
	DT20TB06	DT24TB06	DT30TB06	DT35TB06



ABUTMENTS

	NP	RP	WP	6.0
	NP/3.5	RP/4.3	WP/5.0	6.0
0°	13.004	13.005	13.006	
15°	22.004*	22.005*	22.006*	
25°		23.005*		



SCREW UG

		19.004	19.005	19.005	19.005
10 Pack.		19.004-P10	19.005-P10	19.005-P10	19.005-P10
DLC		19.204	19.205	19.205	19.205
TiN		19.604*	19.605*	19.605*	19.605*
Recommended torque		35 Ncm	35 Ncm	35 Ncm	35 Ncm



PRE-MILLED BLANK

Ø 10mm	Ti	61.004	61.005	61.006	61.097
Ø 14mm	Ti		62.005	62.006	62.097
Ø 14mm	CoCr	71.004	71.005	71.006	71.097



CoCr BASE

○	30.004	30.005	30.006
◊	31.004	31.005	31.006



CASTABLE

○	28.004	28.005	28.006
◊	29.004	29.005	29.006



“Great things are done by a series of small things brought together”

A business without quality will not last. Terrats Medical is in its third generation and we want to honour our heritage with the highest requirements for quality in all we do.





EXTERNAL HEX UNIVERSAL

compatible with
Nobel Brånemark®

-  non-engaging
-  engaging



HEALING ABUTMENT

	NP	RP	WP
	NP/3.5	RP/4.1	WP/5.1
GH 3,0mm	20.001/3	20.002/3	20.003/3
GH 4,0mm	20.001/4	20.002/4	20.003/4
GH 5,0mm	20.001/5	20.002/5	20.003/5



SCAN ABUTMENTS



52.001	52.002	52.003
--------	--------	--------



EXTISA extender for 52.xxx.



52.xxx includes manual tool DTPEIPEEK.



TRANSFER

17.041	17.042	17.043
--------	--------	--------

Transfers include two screws (for open and closed tray).



Platform Colour Coded

DIGITAL ANALOGUE

Retention screw Hex 1,27 mm*

*Other retention screws available, see page 159

NP	RP	WP
NP/3.5	RP/4.1	WP/5.1
14.001/D	14.002/D	14.003/D



Platform Colour Coded

ANALOGUE

10 Pack.

14.001	14.002	14.003
	14.002-P10	



TEMPORARY ABUTMENT



24.001	24.002	24.003
--------	--------	--------













25.001	25.002	25.003
--------	--------	--------

DESSLoc®







GH 1,0mm	88.001/1	88.002/1
GH 2,0mm	88.001/2	88.002/2
GH 3,0mm	88.001/3	88.002/3
GH 4,0mm		88.002/4
GH 5,0mm		88.002/5





MULTI-UNIT ABUTMENTS			NP	RP	WP
			NP/3.5	RP/4.1	WP/5.1
GH 1,0mm	0°		40.001/1	40.002/1	40.003/1
GH 2,0mm	0°		40.001/2	40.002/2	40.003/2
GH 3,0mm	0°		40.001/3	40.002/3	40.003/3
GH 4,0mm	0°			40.002/4	
GH 5,0mm	0°			40.002/5	
GH 2,0mm	17°		41.701/2*	41.702/2*	
GH 3,0mm	17°		41.701/3*	41.702/3*	
GH 4,0mm	17°			41.702/4*	
GH 4,0mm	30°			43.002/4*	
GH 5,0mm	30°			43.002/5*	









4.8 MULTI-UNIT PLATFORM 6.5

TI-BASE			NP	RP	WP
GH 0,3mm			15.001	15.002	15.003
GH 1,5mm			15.201	15.202	15.203
GH 3,0mm			15.301	15.302	15.303
GH 0,3mm			16.001	16.002	16.003
GH 1,5mm			16.201	16.202	16.203
GH 3,0mm			16.301	16.302	16.303



TI-BASE CASTABLES			NP	RP	WP
5 Pack.			32.001-P5	32.001-P5	32.003-P5
5 Pack.			33.001-P5	33.001-P5	33.003-P5







ANGLEBase®			NP	RP	WP
			NP/3.5	RP/4.1	WP/5.1
GH 0,3mm			36.001	36.002	
GH 1,5mm			36.001/2	36.002/2	
GH 2,5mm			36.001/3	36.002/3	
GH 0,3mm			37.001	37.002	
GH 1,5mm			37.001/2	37.002/2	
GH 2,5mm			37.001/3	37.002/3	



PLASTIC SLEEVES FOR ANGLEBase®

5 Pack.		0°	33.100-P5	33.100-P5
5 Pack.		10°	33.101-P5	33.101-P5
5 Pack.		20°	33.102-P5	33.102-P5



C-Base®			NP	RP	WP
GH 1,5mm			58.001/2	58.002/2	
GH 3,0mm			58.001/3	58.002/3	
GH 0,6mm			59.001	59.002	
GH 1,5mm			59.001/2	59.002/2	
GH 3,0mm			59.001/3	59.002/3	



Includes screw, same as standard screw.

Libraries available for EXOCAD & 3Shape.

Torx® Screw ANGLEBase®			NP	RP	WP
(replacement screw)			19.401	19.402	
Recommended torque			35 Ncm	35 Ncm	



Torx® BALL SCREWDRIVER		20mm	24mm	30mm	35mm
		DT20TB06	DT24TB06	DT30TB06	DT35TB06





ABUTMENTS

	NP	RP	WP
	NP/3.5	RP/4.1	WP/5.1
0°	13.001	13.002	13.003
15°	22.001*	22.002*	22.003*
25°		23.002*	



SCREW UG

		19.027	19.028	19.029
10 Pack.		19.027-P10	19.028-P10	
DLC		19.227	19.228	19.229
TiN		19.627*	19.628*	19.629*
Recommended torque		35 Ncm	35 Ncm	35 Ncm





PRE-MILLED BLANK

Ø 10mm	Ti	61.001	61.002	61.003
Ø 14mm	CoCr	71.001	71.002	71.003



CoCr BASE

	30.001	30.002	30.003
	31.001	31.002	31.003
		30.102*	

FOR WELDING TECHNIQUES

CASTABLE

	28.001	28.002	28.003
	29.001	29.002	29.003



“The difference between something good and something exceptional is in the smallest detail”

At DESS® we believe that no detail is too small to escape close attention. That’s why our exhaustive quality controls in every single part of the manufacturing process ensure that the quality of our products is guaranteed. Our confidence is such that we offer a lifetime warranty on all our products.





EXTERNAL HEX USA

compatible with
3i® Osseotite®

○ non-engaging

⬡ engaging



HEALING ABUTMENT

	NP	RP	WP
	3.4	4.1	5.0
GH 3,0mm	20.011/3	20.012/3	20.013/3
GH 4,0mm	20.011/4	20.012/4	20.013/4
GH 5,0mm	20.011/5	20.012/5	20.013/5



SCAN ABUTMENTS



52.011	52.012	52.013
--------	--------	--------



EXTISA extender for 52.xxx.



52.xxx includes manual tool DTPEIPEEK.



TRANSFER

17.011	17.012	17.013
--------	--------	--------

Transfers include two screws (for open and closed tray).



Platform Colour Coded

DIGITAL ANALOGUE

Retention screw Hex 1,27 mm*

*Other retention screws available, see page 159



Platform Colour Coded

ANALOGUE

10 Pack.

NP	RP	WP
3.4	4.1	5.0
14.011/D	14.012/D	14.013/D

14.011	14.012	14.013
14.012-P10		



TEMPORARY ABUTMENT



24.011	24.012	24.013
--------	--------	--------



25.011	25.012	25.013
--------	--------	--------



DESSLoc®

GH 1,0mm	88.011/1	88.012/1	88.013/1
GH 2,0mm	88.011/2	88.012/2	88.013/2
GH 3,0mm	88.011/3	88.012/3	88.013/3
GH 4,0mm	88.011/4	88.012/4	88.013/4
GH 5,0mm	88.011/5	88.012/5	88.013/5
GH 6,0mm	88.011/6 FDA & Canada only		88.013/6 FDA & Canada only



MULTI-UNIT ABUTMENTS

			NP	RP	WP
			3.4	4.1	5.0
GH 1,0mm	0°	○	40.009/1	40.017/1	
GH 2,0mm	0°	○	40.009/2	40.017/2	
GH 3,0mm	0°	○	40.009/3	40.017/3	
GH 4,0mm	0°	○		40.017/4	
GH 5,0mm	0°	○		40.017/5	
GH 2,0mm	17°	⬡		41.712/2	
GH 3,0mm	17°	⬡		41.712/3	
GH 4,0mm	17°	⬡		41.712/4	
GH 3,0mm	30°	⬡		43.012/3	
GH 4,0mm	30°	⬡		43.012/4	
GH 5,0mm	30°	⬡		43.012/5	

4.8
MULTI-UNIT PLATFORM

TI-BASE

GH 0,3mm	○	15.011	15.012	15.013
GH 1,5mm	○	15.211	15.212	15.213
GH 3,0mm	○	15.311	15.312	15.313
GH 0,3mm	⬡	16.011	16.012	16.013
GH 1,5mm	⬡	16.211	16.212	16.213
GH 3,0mm	⬡	16.311	16.312	16.313

TI-BASE CASTABLES

5 Pack.	○	32.001-P5	32.001-P5	32.001-P5
5 Pack.	⬡	33.001-P5	33.001-P5	33.001-P5



ANGLEBase®

			NP	RP	WP
			3.4	4.1	5.0
GH 0,3mm	○		36.011	36.012	36.013
GH 1,5mm	○		36.011/2	36.012/2	
GH 2,5mm	○		36.011/3	36.012/3	
GH 0,3mm	⬡		37.011	37.012	37.013
GH 1,5mm	⬡		37.011/2	37.012/2	
GH 2,5mm	⬡		37.011/3	37.012/3	



PLASTIC SLEEVES FOR ANGLEBase®



5 Pack.	0°	33.100-P5	33.100-P5	33.100-P5
5 Pack.	10°	33.101-P5	33.101-P5	33.101-P5
5 Pack.	20°	33.102-P5	33.102-P5	33.102-P5

C-Base®

GH 1,5mm	○	58.011/2	58.012/2	58.013/2
GH 3,0mm	○	58.011/3	58.012/3	58.013/3
GH 0,6mm	⬡	59.011	59.012	59.013
GH 1,5mm	⬡	59.011/2	59.012/2	59.013/2
GH 3,0mm	⬡	59.011/3	59.012/3	59.013/3



Includes screw, same as standard screw.

Libraries available for EXOCAD & 3Shape.

Torx® Screw ANGLEBase®

(replacement screw)

Recommended torque

19.402	19.402	19.402
20 Ncm	20 Ncm	20 Ncm



Torx® BALL SCREWDRIVER

	20mm	24mm	30mm	35mm
	DT20TB06	DT24TB06	DT30TB06	DT35TB06





ABUTMENTS

	NP	RP	WP
	3.4	4.1	5.0
0°	13.011	13.012	13.013
15°	22.011*	22.012*	22.013*
25°		23.012*	



SCREW HEX 1,20mm

		19.034	19.034	19.034
	10 Pack.	19.034-P10	19.034-P10	19.034-P10
	TiN	19.634*	19.634*	19.634*
<i>Recommended torque</i>		<i>20 Ncm</i>	<i>20 Ncm</i>	<i>20 Ncm</i>

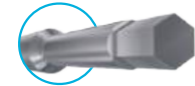



PRE-MILLED BLANK

Ø 10mm	Ti	61.011	61.012	61.013
Ø 14mm	CoCr	71.011	71.012	71.013



CoCr BASE

	30.011	30.012	30.013
	31.011	31.012	31.013



CASTABLE

	28.011	28.012	28.013
	29.011	29.012	29.013



“There is no good idea that cannot be improved”

We are proud to say that innovation and quality are at the center of our core values. We look at different solutions and re-engineer them to provide better and more reliable alternatives. Products like our intra-oral scan abutment without a screw hole, which improves substantially the image precision, our angled Multi-unit abutment with a fully shaped connection and vertical access for more stability and less screw loosening or our angulated screw channel solution ANGLEBase® that allows you 25° angle with a 360° rotation, are clear examples of our way of doing things.





INTERNAL HEX "CLICK"

compatible with
3i Certain®

○ non-engaging

⬡ engaging



HEALING ABUTMENT

	NP	RP	WP
	3.4	4.1	5.0
GH 3,0mm	20.014/3	20.015/3	20.016/3
GH 4,0mm	20.014/4	20.015/4	20.016/4
GH 5,0mm	20.014/5	20.015/5	20.016/5



SCAN ABUTMENTS



EXTISA extender for 52.xxx.



52.xxx includes manual tool DTPEIPEEK.

52.014	52.015	52.016
--------	--------	--------



TRANSFER

17.014	17.015	17.016
--------	--------	--------

Transfers include two screws (for open and closed tray).



Platform Colour Coded



Platform Colour Coded



DIGITAL ANALOGUE

Retention screw Hex 1,27 mm*

*Other retention screws available, see page 159

ANALOGUE

10 Pack.

TEMPORARY ABUTMENT



NP	RP	WP
3.4	4.1	5.0
14.014/D	14.015/D	14.016/D

14.014	14.015	14.016
14.015-P10		

○	24.014	24.015	24.016
⬡	25.014	25.015	25.016

DESSLoc®

GH 1,0mm	88.014/1	88.015/1	88.016/1
GH 2,0mm	88.014/2	88.015/2	88.016/2
GH 3,0mm	88.014/3	88.015/3	88.016/3
GH 4,0mm	88.014/4	88.015/4	88.016/4
GH 5,0mm	88.014/5	88.015/5	88.016/5
GH 6,0mm	88.014/6	88.015/6	88.016/6
	FDA & Canada only	FDA & Canada only	FDA & Canada only



TI-BASE

			NP	RP	WP
			3.4	4.1	5.0
	GH 0,3mm	○	15.014	15.015	15.016
	GH 1,5mm	○	15.214	15.215	15.216
	GH 3,0mm	○	15.314	15.315	15.316
	GH 0,3mm	⬡	16.014	16.015	16.016
	GH 1,5mm	⬡	16.214	16.215	16.216
	GH 3,0mm	⬡	16.314	16.315	16.316



TI-BASE CASTABLES

5 Pack.	○	32.001-P5	32.001-P5	32.001-P5
5 Pack.	⬡	33.001-P5	33.001-P5	33.001-P5



ANGLEBase®

	○	36.014	36.015	36.016
	⬡	37.014	37.015	37.016

PLASTIC SLEEVES FOR ANGLEBase®

5 Pack.	0°	33.100-P5	33.100-P5	33.100-P5
5 Pack.	10°	33.101-P5	33.101-P5	33.101-P5
5 Pack.	20°	33.102-P5	33.102-P5	33.102-P5



C-Base®

			NP	RP	WP
			3.4	4.1	5.0
	GH 0,4mm	○	58.014	58.015	
	GH 0,5mm	○			58.016
	GH 1,5mm	○	58.014/2	58.015/2	58.016/2
	GH 3,0mm	○	58.014/3	58.015/3	58.016/3
	GH 0,4mm	⬡	59.014	59.015	
	GH 0,5mm	⬡			59.016
	GH 1,5mm	⬡	59.014/2	59.015/2	59.016/2
	GH 3,0mm	⬡	59.014/3	59.015/3	59.016/3

Includes screw, same as standard screw.

Libraries available for EXOCAD & 3Shape.

Torx® Screw ANGLEBase®



(replacement screw)	19.438	19.438	19.438
Recommended torque	20 Ncm	20 Ncm	20 Ncm

Torx® BALL SCREWDRIVER



	20mm	24mm	30mm	35mm
	DT20TB06	DT24TB06	DT30TB06	DT35TB06

ABUTMENTS



0°	13.014	13.015	13.016
15°	22.014*	22.015*	22.016*
25°		23.015*	

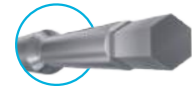

SCREW HEX 1,20mm

	NP	RP	WP
	3.4	4.1	5.0
	19.011	19.011	19.011
10 Pack.	19.011-P10	19.011-P10	19.011-P10
TiN	19.611*	19.611*	19.611*
Recommended torque	20 Ncm	20 Ncm	20 Ncm



PRE-MILLED BLANK

	NP	RP	WP
Ø 10mm Ti	61.014	61.015	61.016
Ø 14mm Ti		62.015	62.016
Ø 14mm CoCr			71.016



CoCr BASE

	NP	RP	WP
○	30.014	30.015	30.016
⬡	31.014	31.015	31.016



CASTABLE

	NP	RP	WP
○	28.014	28.015	28.016
⬡	29.014	29.015	29.016

CONICAL BLT IMPLANT

The first **Zero Waste** implant on the market



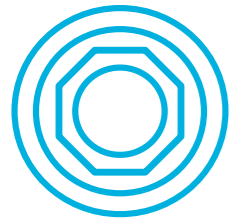

OCTAGON

compatible with
Straumann® Tissue level & synOcta®

○ non-engaging

◊ engaging



HEALING ABUTMENT

	NNC	RN	WN
	3.5	4.1/4.8	4.8/6.5
GH 2,0mm		20.009/2	20.045/2
GH 3,0mm		20.009/3	20.045/3
GH 4,0mm		20.009/4	20.045/4
On abutment		20.010	20.049



CONVERTER ABUTMENT

	○	35.001	
	◊	34.001	34.002



SCAN ABUTMENTS

	On abutment	52.070	52.009	52.045
			52.010	52.048

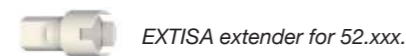

TRANSFER

	NNC	RN	WN
	3.5	4.1/4.8	4.8/6.5
	17.070	17.009	17.053
On abutment		17.010	17.048

Transfers include two screws (for open and closed tray).



Platform Colour Coded

DIGITAL ANALOGUE

Retention screw Hex 1,27 mm*	14.070/D	14.009/D	14.045/D
On abutment		14.010/D	14.046/D

*Other retention screws available, see page 159



Platform Colour Coded

ANALOGUE

	14.070	14.009	14.045
10 Pack.		14.009-P10	
On abutment		14.010	14.046



TEMPORARY ABUTMENT

	○	24.026	24.045
	◊	25.009	25.045
On abutment	○	24.010	24.047
	◊	25.026	25.047



DESSLoc®

	NNC	RN	WN
	3.5	4.1/4.8	4.8/6.5
GH 1,0mm		88.009/1	
GH 2,0mm		88.009/2	
GH 3,0mm		88.009/3	
GH 4,0mm		88.009/4	

TI-BASE



GH 0,3mm		○		15.045
GH 0,4mm		○		15.046
GH 0,5mm	15.070	○		
GH 0,3mm		⊕		16.045
GH 0,4mm		⊕		16.009
GH 0,5mm	16.070	⊕		
On abutment GH 0,3mm		○	15.010	15.048
GH 0,3mm		⊕	16.010	16.048



TI-BASE CASTABLES

5 Pack.		○	32.001-P5	32.046-P5	32.045-P5
5 Pack.		⊕	33.001-P5	33.009-P5	33.045-P5
On abutment 5 Pack.		○		32.010-P5	32.045-P5
5 Pack.		⊕		33.010-P5	33.045-P5

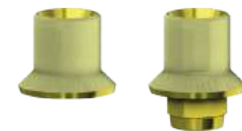

ANGLEBase®

		○		36.046	36.047
		⊕		37.009	37.045

PLASTIC SLEEVES FOR ANGLEBase®



5 Pack.	0°		33.200-P5	33.300-P5
5 Pack.	10°		33.201-P5	33.301-P5
5 Pack.	20°		33.202-P5	33.302-P5



C-Base®

	NNC	RN	WN
	3.5	4.1/4.8	4.8/6.5
GH 1,0mm		○	58.009
GH 1,2mm		○	58.045
GH 1,0mm		⊕	59.009
GH 1,2mm		⊕	59.045

Includes screw, same as standard screw.

Libraries available for EXOCAD & 3Shape.

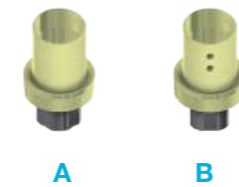

ELLIPTIBase®

A corner	◇	56.070
B flat	▭	57.070

Torx® Screw
ANGLEBase® & ELLIPTIBase®



(replacement screw)

Recommended torque

19.441 19.446 19.446

35 Ncm 35 Ncm 36 Ncm

Torx® BALL SCREWDRIVER



	20mm	24mm	30mm	35mm
	DT20TB06	DT24TB06	DT30TB06	DT35TB06



	NNC	RN	WN
ABUTMENTS	3.5	4.1/4.8	4.8/6.5
0°		13.009	
15°		22.009*	
25°		23.009*	

**inc.captive screw*



	NNC	RN	WN
SCREW TORX®			
	19.070	19.026	19.026
10 Pack.		19.026-P10	19.026-P10
TiN	19.670*	19.626*	19.626*
<i>Recommended torque</i>	<i>35 Ncm</i>	<i>35 Ncm</i>	<i>35 Ncm</i>
On abutment		19.009	19.009
TiN		19.609*	19.609*
<i>Recommended torque</i>		<i>15 Ncm</i>	<i>15 Ncm</i>



	NNC	RN	WN
PRE-MILLED BLANK			
Ø 10mm Ti	61.070	61.009	61.045
Ø 14mm Ti		62.009	62.045
Ø 14mm CoCr	71.070		



	NNC	RN	WN
CoCr BASE	3.5	4.1/4.8	4.8/6.5
		30.009	30.045
		31.009	31.045
For welding techniques		30.109*	30.145*
		31.109*	31.145*
On abutment		30.010	30.048
		31.010	31.048
For welding techniques		30.110*	



	NNC	RN	WN
CASTABLE			
			28.045
		29.009	29.045
On abutment		28.010	28.046
On abutment		29.010	29.046

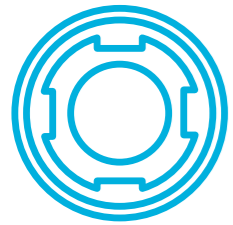

CONICAL BL

compatible with
Straumann® Bone level

○ non-engaging

◻ engaging



HEALING ABUTMENT

	NP	RP	NP/RP
	NC/3.3	RC/4.1-4.8	NC/RC
GH 3,0mm	20.041/3	20.042/3	
GH 4,0mm	20.041/4	20.042/4	
GH 5,0mm	20.041/5	20.042/5	



SCAN ABUTMENTS



On abutment SRA

	NP	RP	NP/RP
	52.043	52.044	
			52.098



EXTISA extender for 52.xxx.



52.xxx includes manual tool DTPEIPEEK.



TRANSFER

	NP	RP	NP/RP
	17.046	17.047	
	Transfers include two screws (for open and closed tray).		



DIGITAL ANALOGUE

Retention screw Hex 1,27 mm*

OF SRA

4,6 Ø

*Other retention screws available, see page 159



ANALOGUE

Platform Colour Coded

10 Pack.

OF SRA

4,6 Ø



TEMPORARY ABUTMENT

	NP	RP	NP/RP
	24.043	24.044*	
	25.043	25.044	
On abutment SRA	4,6 Ø		24.098
			25.098



DESSLoc®

GH 1,0mm		88.042/1
GH 2,0mm	88.041/2	88.042/2
GH 3,0mm	88.041/3	88.042/3
GH 4,0mm	88.041/4	88.042/4



MULTI-UNIT ABUTMENTS

	GH	Angle	Icon	NP	RP	NP/RP
				NC/3.3	RC/4.1-4.8	NC/RC
	GH 1,5mm	0°	○	40.043/1	40.044/1	
	GH 2,5mm	0°	○	40.043/2	40.044/2	
	GH 3,5mm	0°	○	40.043/3	40.044/3	
	GH 4,5mm	0°	○		40.044/4	
	GH 2,5mm	17°	⊕	41.743/2	41.744/2	
	GH 3,5mm	17°	⊕	41.743/3	41.744/3	
	GH 3,5mm	30°	⊕	43.043/3	43.044/3	
	GH 4,5mm	30°	⊕	43.043/4	43.044/4	

4.8
MULTI-UNIT PLATFORM



NEW MUA+

	GH 1,5mm	0°	○	42.443/1	42.444/1	
	GH 2,5mm	0°	○	42.443/2	42.444/2	
	GH 3,5mm	0°	○	42.443/3	42.444/3	
	GH 4,5mm	0°	○		42.444/4	



A

B

A corner	GH 2,5mm	17°	⊕	46.443/2	46.444/2	
B flat	GH 2,5mm	17°	⊕	46.491/2*	46.492/2*	
A corner	GH 3,5mm	17°	⊕	46.443/3	46.444/3	
B flat	GH 3,5mm	17°	⊕	46.491/3*	46.492/3*	
A corner	GH 3,5mm	30°	⊕	47.443/3	47.444/3	
B flat	GH 3,5mm	30°	⊕	47.491/3*	47.492/3*	
A corner	GH 4,5mm	30°	⊕	47.443/4	47.444/4	
B flat	GH 4,5mm	30°	⊕	47.491/4*	47.492/4*	

4.8
MULTI-UNIT PLATFORM



TI-BASE

	GH	Icon	NP	RP	NP/RP
			NC/3.3	RC/4.1-4.8	NC/RC
	GH 1,2mm	○		15.044	
	GH 1,5mm	○	NEW 15.443		
	GH 2,0mm	○		15.044/2	
	GH 3,0mm	○		15.344	
	GH 1,2mm	⊕		16.044	
	GH 1,5mm	⊕	NEW 16.443		
	GH 2,0mm	⊕		16.044/2	
	GH 3,0mm	⊕		16.344	
ON SRA	4,6 Ø	○			15.098
		⊕			16.098



TI-BASE CASTABLES

	5 Pack.	○		32.001-P5	
	5 Pack.	⊕		33.001-P5	
ON SRA	4,6 Ø / 5 Pack.	○			32.098-P5
	5 Pack.	⊕			33.098-P5

ANGLEBase®

	○	36.043	36.044
	⊕	37.043	37.044

PLASTIC SLEEVES FOR ANGLEBase®



	5 Pack.	0°	33.100-P5	33.100-P5
	5 Pack.	10°	33.101-P5	33.101-P5
	5 Pack.	20°	33.102-P5	33.102-P5



C-Base®

	GH 0,7mm	○	58.043*	58.044
	GH 3,0mm	○	58.043/3	58.044/3
	GH 0,7mm	⊕	59.043	59.044
	GH 3,0mm	⊕	59.043/3	59.044/3

Includes screw, same as standard screw.

Libraries available for EXOCAD & 3Shape.

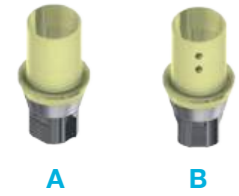

ELLIPTIBase®

		NP	RP	NP/RP
A corner		NC/3.3	RC/4.1-4.8	NC/RC
B flat		56.043		
		57.043		

Torx® Screw
ANGLEBase® & ELLIPTIBase® & ASC BLANK



<i>(replacement screw)</i>		19.443	19.443	
<i>Recommended torque</i>		35 Ncm	35 Ncm	

Torx® BALL SCREWDRIVER



	20mm	24mm	30mm	35mm
	DT20TB06	DT24TB06	DT30TB06	DT35TB06

ABUTMENTS



0°	13.043	13.044
15°	22.043*	22.044*

SCREW TORX®



		19.032	19.033	19.037
10 Pack.		19.032-P10	19.033-P10	19.037-P10
TiN		19.632*	19.633*	19.637*
<i>Recommended torque</i>		35 Ncm	35 Ncm	35 Ncm



On abutment SRA	4,6 Ø			19.098
10 Pack.				19.098-P10
TiN				19.698*

Recommended torque 15 Ncm



PRE-MILLED BLANK

		NP	RP	NP/RP
Ø 10mm	Ti	NC/3.3	RC/4.1-4.8	NC/RC
Ø 14mm	Ti	61.043	61.044	
Ø 14mm	CoCr	62.043	62.044	
			71.044	



NEW
ASC BLANK

Ø 14mm	Ti	A corner		61.343*	61.344*
Ø 14mm	Ti	B flat		71.343*	71.344*

CoCr BASE



			30.043	30.044
			31.043	31.044
On abutment SRA	4,6 Ø			30.098*
				31.098*

CASTABLE



			28.043	28.044
			29.043	29.044

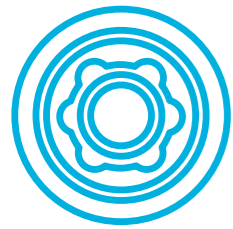

CONICAL BLX

compatible with
Straumann® BLX

○ non-engaging

⬡ engaging



HEALING ABUTMENT

	RB/WB	WB
	3.5	4.5

GH 0,8mm ^{A/B}		20.463/1
GH 1,5mm ^A	20.461/2	20.461/2
GH 1,5mm ^B	20.462/2	20.462/2
GH 1,5mm ^{A/B}		20.463/2
GH 2,5mm ^A	20.461/3	20.461/3
GH 2,5mm ^B	20.462/3	20.462/3
GH 3,5mm ^A	20.461/4	20.461/4
GH 3,5mm ^B	20.462/4	20.462/4

^Afor single crown restoration ^Bfor bridges and structures restorations



SCAN ABUTMENTS



	RB/WB	WB
	52.062	52.062

EXTISA extender for 52.xxx.

52.xxx includes manual tool DTPEIPEEK.

TRANSFER

	RB/WB	WB
	17.062	17.062

Transfers include two screws (for open and closed tray).



Platform Colour Coded

DIGITAL ANALOGUE

Retention screw Hex 1,27 mm*

*Other retention screws available, see page 159

	RB/WB	WB
	3.5	4.5

	14.062/D	14.063/D
--	----------	----------



Platform Colour Coded

ANALOGUE

	14.062	14.063
--	--------	--------







MULTI-UNIT ABUTMENTS

GH 1,5mm	0°	○	40.062/1	40.062/1
GH 2,5mm	0°	○	40.062/2	40.062/2
GH 3,5mm	0°	○	40.062/3	40.062/3
GH 2,5mm	17°	⬡	41.762/2	41.762/2
GH 3,5mm	17°	⬡	41.762/3	41.762/3
GH 3,5mm	30°	⬡	43.062/3	43.062/3
GH 4,5mm	30°	⬡	43.062/4	43.062/4

4.8
MULTI-UNIT PLATFORM



TI-BASE

		RB/WB	WB
		3.5	4.5
GH 0,8mm			15.063
GH 1,5mm		 15.462	15.063/2
GH 0,8mm			16.063
GH 1,5mm		 16.462	16.063/2



TI-BASE CASTABLES

		3.5	4.5
5 Pack.		32.001-P5	32.001-P5
5 Pack.		33.001-P5	33.001-P5



ANGLEBase®

		3.5	4.5
GH 1,5mm		36.062	36.063
GH 1,5mm		37.062	37.063



PLASTIC SLEEVES FOR ANGLEBase®

		3.5	4.5
5 Pack.	0°	33.100-P5	33.100-P5
5 Pack.	10°	33.101-P5	33.101-P5
5 Pack.	20°	33.102-P5	33.102-P5



Torx® Screw ANGLEBase®

(replacement screw)

Recommended torque

	RB/WB	WB
	3.5	4.5
	19.441	19.441
35 Ncm	35 Ncm	35 Ncm



Torx® BALL SCREWDRIVER

	20mm	24mm	30mm	35mm
	DT20TB06	DT24TB06	DT30TB06	DT35TB06



SCREW TORX®

TiN

Recommended torque

	19.054	19.054
TiN	19.700*	19.700*
35 Ncm	35 Ncm	35 Ncm



PRE-MILLED BLANK

Ø 10mm	Ti	61.062
Ø 14mm	Ti	62.063
Ø 14mm	CoCr	71.063



NEO GM

compatible with
Neodent® Grand Morse

○ non-engaging

⬡ engaging



SCAN ABUTMENTS



GM

52.035



EXTISA extender for 52.xxx.



52.xxx includes manual tool DTPEIPEEK.



TRANSFER

17.035

Transfers include two screws (for open and closed tray).



DIGITAL ANALOGUE

Retention screw Hex 1,27 mm*

14.035/D

*Other retention screws available, see page 159



Platform Colour Coded



ANALOGUE

14.035



Platform Colour Coded



NEW
MUA+

GM

GH 0,8mm	0°	○	42.435/1
GH 1,5mm	0°	○	42.435/2
GH 2,5mm	0°	○	42.435/3
GH 3,5mm	0°	○	42.435/4
GH 1,5mm	17°	⬡	46.435/2
GH 2,5mm	17°	⬡	46.435/3
GH 1,5mm	30°	⬡	47.435/3
GH 2,5mm	30°	⬡	47.435/4



GH

MULTI-UNIT ABUTMENTS

GH 1,5mm	0°	○	40.035/1
GH 2,5mm	0°	○	40.035/2
GH 3,5mm	0°	○	40.035/3
GH 2,5mm	17°	⬡	41.735/2
GH 3,5mm	17°	⬡	41.735/3
GH 3,5mm	30°	⬡	43.035/3
GH 4,5mm	30°	⬡	43.035/4



GH

NEW
TI-BASE

GH 1,5mm	○	15.455
GH 1,5mm	⬡	16.455



GM



ANGLEBase®

GH 2,5mm	○	36.035/3
GH 2,5mm	⬡	37.035/3

PLASTIC SLEEVES FOR ANGLEBase®



5 Pack.	0°	33.100-P5
5 Pack.	10°	33.101-P5
5 Pack.	20°	33.102-P5

Torx® Screw ANGLEBase®



(replacement screw)	19.444
Recommended torque	20 Ncm

Torx® BALL SCREWDRIVER



	20mm	24mm	30mm	35mm
	DT20TB06	DT24TB06	DT30TB06	DT35TB06

SCREW NEO



	19.051
Recommended torque	20 Ncm

PRE-MILLED BLANK



Ø 10mm	Ti	61.035
Ø 14mm	Ti	62.035
Ø 14mm	CoCr	71.035

ACTIVE HEX® IMPLANT

The first **Zero Waste** implant on the market



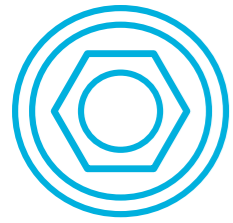

INTERNAL HEX USA

compatible with
Zimmer Screw-Vent®

○ non-engaging
⬡ engaging



HEALING ABUTMENT

	NP	RP	WP
	3.5	4.5	5.7
GH 3,0mm	20.017/3	20.018/3	20.019/3
GH 4,0mm	20.017/4	20.018/4	20.019/4
GH 5,0mm	20.017/5	20.018/5	20.019/5



SCAN ABUTMENTS



EXTISA extender for 52.xxx.



52.xxx includes manual tool DTPEIPEEK.

	NP	RP	WP
	52.017	52.018	52.019



TRANSFER

	NP	RP	WP
	17.017	17.018	17.019

Transfers include two screws (for open and closed tray).



Platform Colour Coded

DIGITAL ANALOGUE

Retention screw Hex 1,27 mm*

*Other retention screws available, see page 159

	NP	RP	WP
	14.017/D	14.018/D	14.019/D



Platform Colour Coded

ANALOGUE

10 Pack.

	NP	RP	WP
	14.017	14.018	14.019
	14.017-P10	14.018-P10	



TEMPORARY ABUTMENT

	NP	RP	WP
	3.5	4.5	5.7
○	24.017	24.018	24.019
⬡	25.017	25.018	25.019



DESSLoc®

	NP	RP	WP
GH 1,0mm	88.017/1	88.018/1	88.019/1
GH 2,5mm	88.017/2	88.018/2	88.019/2
GH 3,5mm	88.017/3	88.018/3	88.019/3
GH 4,5mm	88.017/4	88.018/4	88.019/4
GH 5,5mm	88.017/5	88.018/5	88.019/5
GH 6,5mm	88.017/6 FDA & Canada only	88.018/6 FDA & Canada only	88.019/6 FDA & Canada only











MULTI-UNIT ABUTMENTS

				NP	RP
GH 1,0mm	0°	○		40.019/1	40.020/1
GH 2,0mm	0°	○		40.019/2	40.020/2
GH 3,0mm	0°	○		40.019/3	40.020/3
GH 4,0mm	0°	○		40.019/4	40.020/4
GH 5,0mm	0°	○		40.019/5	40.020/5
GH 2,5mm	17°	⬡		41.719/2	41.720/2
GH 3,5mm	17°	⬡		41.719/3	41.720/3
GH 3,5mm	30°	⬡		43.019/3	43.020/3
GH 4,5mm	30°	⬡		43.019/4	43.020/4

4.8
MULTI-UNIT PLATFORM





TI-BASE		NP	RP	WP
		3.5	4.5	5.7
GH 0,3mm			15.018	15.019
GH 1,5mm		 15.430	15.218	15.219
GH 3,0mm			15.318	15.319
GH 0,3mm			16.018	16.019
GH 1,5mm		 16.430	16.218	16.219
GH 3,0mm			16.318	16.319

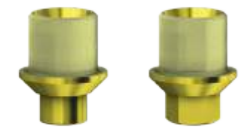

TI-BASE CASTABLES				
5 Pack.			32.001-P5	32.001-P5
5 Pack.			33.001-P5	33.001-P5









ANGLEBase®					
			36.017	36.018	36.019
			37.017	37.018	37.019



PLASTIC SLEEVES FOR ANGLEBase®					
5 Pack.	0°		33.100-P5	33.100-P5	33.100-P5
5 Pack.	10°		33.101-P5	33.101-P5	33.101-P5
5 Pack.	20°		33.102-P5	33.102-P5	33.102-P5





C-Base®		NP	RP	WP
		3.5	4.5	5.7
GH 0,5mm		58.017	58.018	58.019
GH 1,5mm		58.017/2	58.018/2	58.019/2
GH 3,0mm		58.017/3	58.018/3	58.019/3
GH 0,5mm		59.017	59.018	59.019
GH 1,5mm		59.017/2	59.018/2	59.019/2
GH 3,0mm		59.017/3	59.018/3	59.019/2

Includes screw, same as standard screw.

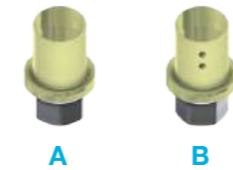
Libraries available for EXOCAD & 3Shape.



ELLIPTIBase®			
A corner			56.017
B flat			57.017



Torx® Screw ANGLEBase® & ELLIPTIBase®					
(replacement screw)			19.417	19.417	19.417
Recommended torque			30 Ncm	30 Ncm	30 Ncm



Torx® BALL SCREWDRIVER	20mm	24mm	30mm	35mm
	DT20TB06	DT24TB06	DT30TB06	DT35TB06



ABUTMENTS					
	0°		13.017	13.018	13.019
	15°		22.017*	22.018*	22.019*
	25°		23.017*	23.018*	



SCREW HEX 1,27mm

	NP	RP	WP
	3.5	4.5	5.7
	19.042	19.042	19.042
10 Pack.	19.042-P10	19.042-P10	19.042-P10
TiN	19.642*	19.642*	19.642*
Recommended torque	30 Ncm	30 Ncm	30 Ncm

PRE-MILLED BLANK



Ø 10mm	Ti	61.017	61.018	61.019
Ø 14mm	Ti	62.017	62.018	62.019
Ø 14mm	CoCr	71.017	71.018	71.019

CoCr BASE



	◯	30.017	30.018	30.019
	◡	31.017	31.018	31.019

CASTABLE



	◯	28.017 19.012	28.018 19.012	28.019 19.012
10 Pack.			11.018-P10	
	◡	29.017 19.012	29.018 19.012	29.019 19.012
10 Pack.		12.017-P10	12.018-P10	

ANGLEBase®

ANGLEBase® is our solution to clinical situations where the the implant's long-axis results in an unfavorable location of the prosthetic screw access hole.



1. 25° Maximum angulation.
2. 360° freedom.
3. SelectGrip®
4. Titanium Grade V.

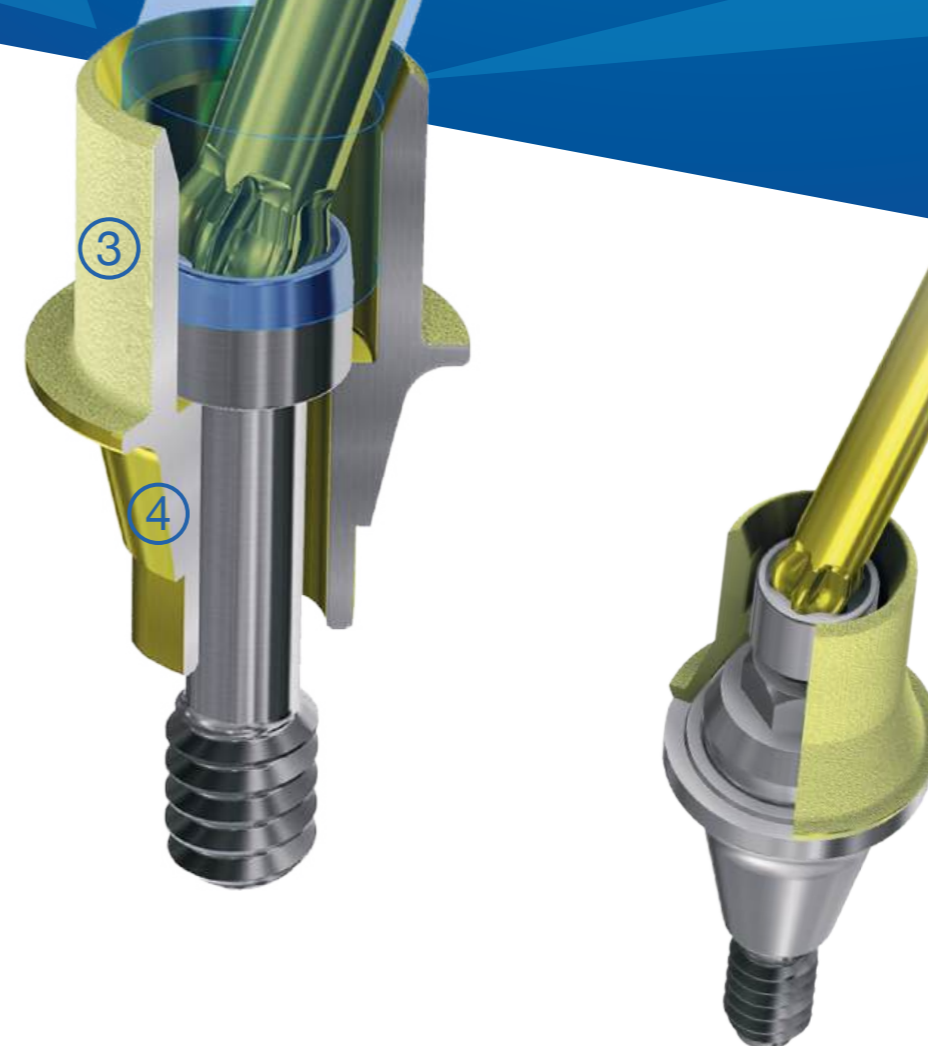

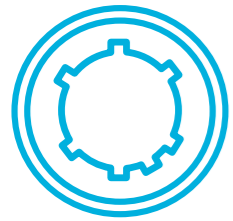

CONIC EVO

compatible with
Astra Tech implant system™ EV

-  non-engaging
-  engaging



HEALING ABUTMENT

	EV/3.0	EV/3.6	EV/4.2	EV/4.8	EV/5.4
	3.0	3.6	4.2	4.8	5.4
GH 3,5mm	20.406/3	20.059/3	20.060/3	20.061/3	20.407/3
GH 4,5mm	20.406/4	20.059/4	20.060/4	20.061/4	20.407/4
GH 6,5mm	20.406/6	20.059/6	20.060/6	20.061/6	20.407/6



SCAN ABUTMENTS

	EV/3.0	EV/3.6	EV/4.2	EV/4.8	EV/5.4
	52.406	52.059	52.060	52.061	52.407
On uniabutment®	52.058				



EXTISA extender for 52.xxx.



52.xxx includes manual tool DTPEIPEEK.



TRANSFER

	EV/3.0	EV/3.6	EV/4.2	EV/4.8	EV/5.4
	17.406	17.059	17.060	17.061	17.407
On uniabutment®	17.058				

Transfers include two screws (for open and closed tray).



Platform Colour Coded

DIGITAL ANALOGUE

	EV/3.0	EV/3.6	EV/4.2	EV/4.8	EV/5.4
	3.0	3.6	4.2	4.8	5.4
Retention screw Hex 1,27 mm*	14.406/D	14.059/D	14.060/D	14.061/D	14.407/D
On uniabutment®	14.058/D				

*Other retention screws available, see page 159



Platform Colour Coded

ANALOGUE

	EV/3.0	EV/3.6	EV/4.2	EV/4.8	EV/5.4
	14.406	14.059	14.060	14.061	14.407
On uniabutment®	14.058				



TEMPORARY ABUTMENT

	EV/3.0	EV/3.6	EV/4.2	EV/4.8	EV/5.4
	24.406	24.059	24.060	24.061	24.407
	25.406	25.059	25.060	25.061	25.407
On uniabutment®	24.058				



DESSLoc®

GH 1,0mm	88.059/1	88.060/1	88.061/1
GH 2,0mm	88.059/2	88.060/2	88.061/2
GH 3,0mm	88.059/3	88.060/3	88.061/3
GH 4,0mm	88.059/4	88.060/4	88.061/4



UNIABUTMENT®

	EV/3.0	EV/3.6	EV/4.2	EV/4.8	EV/5.4
	3.0	3.6	4.2	4.8	5.4

GH 1,0mm		40.059/1	40.060/1	40.061/1	
GH 2,0mm		40.059/2	40.060/2	40.061/2	
GH 3,0mm		40.059/3	40.060/3	40.061/3	
GH 5,0mm		40.059/5	40.060/5	40.061/5	

UniAbutment® needs a 1,75mm hex screwdriver



MULTI-UNIT ABUTMENTS

GH 1,5mm	0°	○	40.406/1	40.027/1	40.036/1	40.037/1	40.407/1
GH 2,5mm	0°	○	40.406/2	40.027/2	40.036/2	40.037/2	40.407/2
GH 3,5mm	0°	○	40.406/3	40.027/3	40.036/3	40.037/3	40.407/3
GH 3,5mm	17°	⊗		41.727/3	41.736/3	41.737/3	
GH 4,5mm	17°	⊗		41.727/4	41.736/4	41.737/4	
GH 4,5mm	30°	⊗		43.027/4	43.036/4	43.037/4	
GH 5,5mm	30°	⊗		43.027/5	43.036/5	43.037/5	

4.8
MULTI-UNIT PLATFORM



TI-BASE

GH 1,0mm	○		15.059	15.060	15.061	15.407
GH 1,5mm	○	NEW 15.406				
GH 3,0mm	○		15.359	15.360	15.361	
GH 1,0mm	⊗		16.059	16.060	16.061	16.407
GH 1,5mm	⊗	NEW 16.406				
GH 3,0mm	⊗		16.359	16.360	16.361	
On uniabutment®	○	15.058				



TI-BASE CASTABLES

5 Pack.	○	32.001-P5	32.001-P5	32.001-P5	32.001-P5
5 Pack.	⊗	33.001-P5	33.001-P5	33.001-P5	33.001-P5
5 Pack.	○	32.001-P5			



ANGLEBase®

	EV/3.0	EV/3.6	EV/4.2	EV/4.8	EV/5.4
	3.0	3.6	4.2	4.8	5.4

	○		36.059	36.060	36.061
	⊗		37.059	37.060	37.061
On uniabutment®	○	36.058			

PLASTIC SLEEVES FOR ANGLEBase®

5 Pack.	0°		33.100-P5	33.100-P5	33.100-P5
5 Pack.	10°		33.101-P5	33.101-P5	33.101-P5
5 Pack.	20°		33.102-P5	33.102-P5	33.102-P5

On Uniabutment®	5 Pack.	0°	33.100-P5
	5 Pack.	10°	33.101-P5
	5 Pack.	20°	33.102-P5



C-Base®

GH 1,0mm	○		58.059	58.060	58.061
GH 3,0mm	○		58.059/3	58.060/3	58.061/3
GH 1,0mm	⊗		59.059	59.060	59.061
GH 3,0mm	⊗		59.059/3	59.060/3	59.061/3

Includes screw, same as standard screw.

Libraries available for EXOCAD & 3Shape.

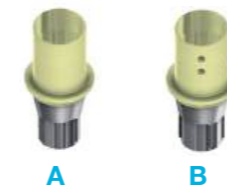

ELLIPTIBase®

A corner	⬠	56.406
B flat	⬡	57.406



Torx® Screw ANGLEBase® & ELLIPTIBase®

(replacement screw)		19.468	19.441	19.460	19.461
Recommended torque		15 Ncm	25 Ncm	25 Ncm	25 Ncm
On uniabutment®		19.331*			
Recommended torque		15 Ncm			

Torx® BALL SCREWDRIVER

	20mm	24mm	30mm	35mm
	DT20TB06	DT24TB06	DT30TB06	DT35TB06





		EV/3.0	EV/3.6	EV/4.2	EV/4.8	EV/5.4
SCREW HEX 1,27mm		3.0	3.6	4.2	4.8	5.4
		19.071	19.059	19.060	19.061	19.061
	TiN	19.671*	19.659*	19.660*	19.661*	19.661*
	Recommended torque	25 Ncm	25 Ncm	25 Ncm	25 Ncm	25 Ncm
On uniabutment®		19.058				
	TiN	19.658*				
	Recommended torque	15 Ncm				

		EV/3.0	EV/3.6	EV/4.2	EV/4.8	EV/5.4
PRE-MILLED BLANK						
Ø 10mm	Ti	61.406	61.059	61.060	61.061	61.407
Ø 14mm	Ti		62.059	62.060	62.061	62.407
Ø 14mm	CoCr		71.059	71.060	71.061	71.407

		EV/3.0	EV/3.6	EV/4.2	EV/4.8	EV/5.4
CoCr BASE						
	○		30.059	30.060	30.061	
	⊗		31.059	31.060	31.061	
On uniabutment®	○	30.058				

		EV/3.0	EV/3.6	EV/4.2	EV/4.8	EV/5.4
CASTABLE						
	○		28.059	28.060	28.061	
On uniabutment®	○	28.058				

The ultimate Multi-Unit

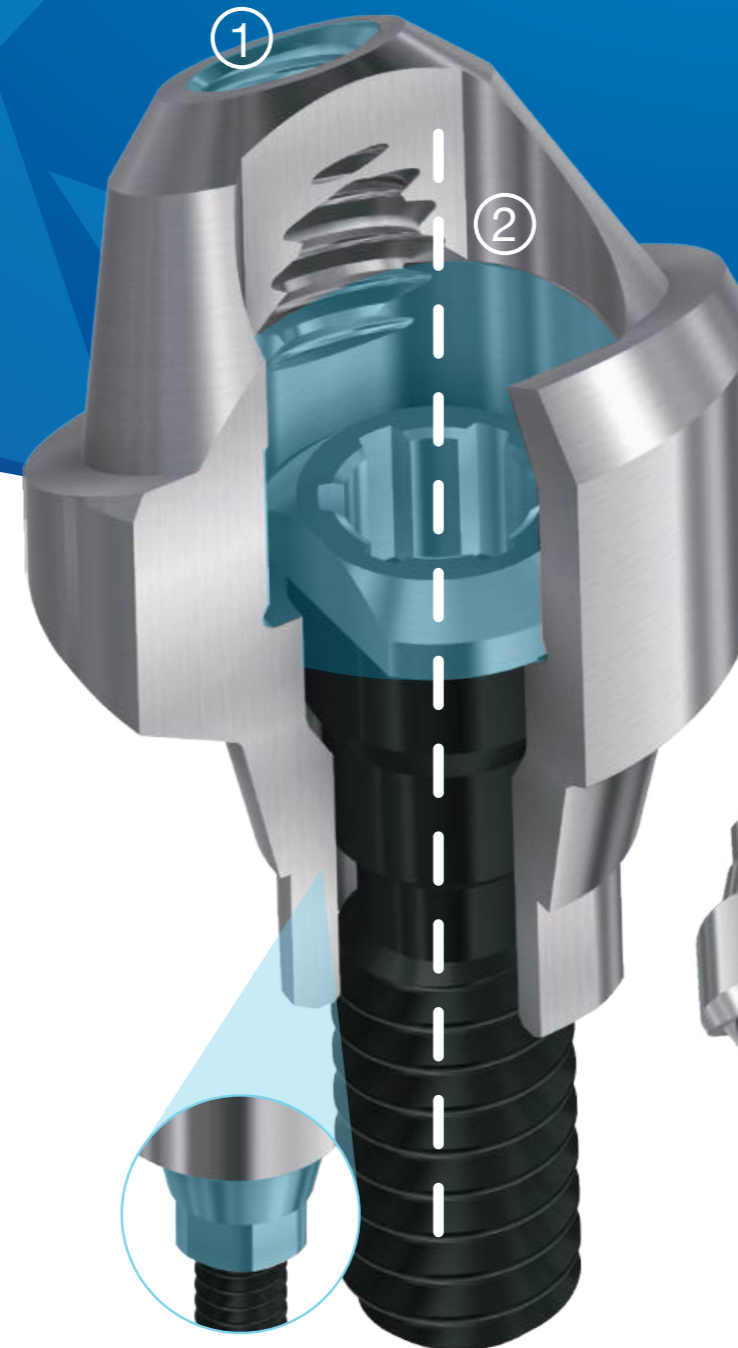

1. A full thread on the connection cone means a more secure and stable prosthesis.

2. Vertical screw access facilitates placement, while allowing tightening to a maximum torque of 35Ncm* to prevent screw loosening and improve the stability of the Multi-Unit abutment.

*According to compatibility

100% compatible with the most popular system on the market.



The Multi-unit angle conveyor has been specially designed to act as a contact point with the screw to prevent it from falling out.



INTERNAL HEX CONIC

compatible with
Astra Tech Osseospeed™

○ non-engaging

○ engaging



HEALING ABUTMENT

		NP	RP	WP
		3.0	3.5-4.0	4.5-5.0
	GH 3,0mm		20.024/3	20.025/3
	GH 4,0mm		20.024/4	20.025/4
	GH 5,0mm		20.024/5	20.025/5
Anatomic	GH 4,0mm	Ø 4,5	20.424/4	
	GH 4,0mm	Ø 5,5	20.524/4	20.525/4
	GH 4,0mm	Ø 6,5		20.625/4



SCAN ABUTMENTS

			NP	RP	WP
			52.023	52.024	52.025
On uniabutment®	20°	52.036			
	45°	52.037			



EXTISA extender for 52.xxx.



52.xxx includes manual tool DTPEIPEEK.



TRANSFER

			NP	RP	WP
			17.023	17.024	17.025
On uniabutment®	20°	17.036			
	45°	17.037			

Transfers include two screws (for open and closed tray).



Platform Colour Coded

DIGITAL ANALOGUE

			NP	RP	WP
			3.0	3.5-4.0	4.5-5.0
	Retention screw Hex 1,27 mm*		14.023/D	14.024/D	14.025/D
Of uniabutment®	20°	14.036/D			
	45°	14.037/D			

*Other retention screws available, see page 159



Platform Colour Coded

ANALOGUE

			NP	RP	WP
			14.023	14.024	14.025
	10 Pack.			14.024-P10	14.025-P10
Of uniabutment®	20°	14.036			
	45°	14.037			



TEMPORARY ABUTMENT

			NP	RP	WP
			24.023*	24.024	24.025
On uniabutment®	20°	○	24.028		
	45°	○	24.029		
		○			
		○			



DESSLoc®

	NP	RP	WP
	3.0	3.5-4.0	4.5-5.0
GH 1,0mm	88.023/1	88.024/1	88.025/1
GH 2,0mm	88.023/2	88.024/2	88.025/2
GH 3,0mm	88.023/3	88.024/3	88.025/3
GH 4,0mm	88.023/4	88.024/4	88.025/4

UNIABUTMENT®

GH 0,5mm	20°	40.013/0	40.015/0
GH 1,0mm	20°	40.013/1	40.015/1
GH 2,0mm	20°	40.013/2	40.015/2
GH 4,0mm	20°	40.013/4	40.015/4
GH 6,0mm	20°	40.013/6	40.015/6
GH 0,5mm	45°	40.014/0	40.016/0
GH 1,0mm	45°	40.014/1	40.016/1
GH 2,0mm	45°	40.014/2	40.016/2
GH 4,0mm	45°	40.014/4	40.016/4
GH 6,0mm	45°	40.014/6	40.016/6

MULTI-UNIT ABUTMENTS

GH 1,5mm	0°	○	40.024/1	40.025/1
GH 2,5mm	0°	○	40.024/2	40.025/2
GH 3,5mm	0°	○	40.024/3	40.025/3
GH 3,5mm	17°	○	41.724/3	41.725/3
GH 4,5mm	17°	○	41.724/4	41.725/4
GH 4,5mm	30°	○	43.024/4	43.025/4
GH 5,5mm	30°	○	43.024/5	43.025/5

4.8
MULTI-UNIT PLATFORM



TI-BASE

	NP	RP	WP
	3.0	3.5-4.0	4.5-5.0
GH 0,9mm	○		15.025
GH 1,1mm	○	15.024	
GH 1,5mm	○	15.423	
GH 2,0mm	○	15.024/2	15.025/2
GH 3,0mm	○	15.324	15.325
GH 0,9mm	○		16.025
GH 1,1mm	○	16.024	
GH 1,5mm	○	16.423	
GH 2,0mm	○	16.024/2	16.025/2
GH 3,0mm	○	16.324	16.325
On uniabutment®	20°	○	15.036
	45°	○	15.037

TI-BASE CASTABLES



5 Pack.	○	32.001-P5	32.001-P5
5 Pack.	○	33.001-P5	33.001-P5

On uniabutment® 32.001-P5

ANGLEBase®

○	36.024	36.025
○	37.024	37.025

PLASTIC SLEEVES FOR ANGLEBase®



5 Pack.	0°	33.100-P5	33.100-P5
5 Pack.	10°	33.101-P5	33.101-P5
5 Pack.	20°	33.102-P5	33.102-P5



C-Base®

		NP 3.0	RP 3.5-4.0	WP 4.5-5.0
GH 0,8mm	○		58.024	
GH 0,9mm	○			58.025
GH 3,0mm	○		58.024/3	58.025/3
GH 0,8mm	○		59.024	
GH 0,9mm	○			59.025
GH 3,0mm	○		59.024/3	59.025/3

Includes screw, same as standard screw.

Libraries available for EXOCAD & 3Shape.



Torx® Screw ANGLEBase®

(replacement screw)

Recommended torque

	19.441	19.425
	20 Ncm	25 Ncm



Torx® BALL SCREWDRIVER

	20mm	24mm	30mm	35mm
	DT20TB06	DT24TB06	DT30TB06	DT35TB06



ABUTMENTS

0°	13.024	13.025
15°	22.024*	22.025*
25°	23.024*	



SCREW HEX 1,27mm

	NP 3.0	RP 3.5-4.0	WP 4.5-5.0
	19.015	19.016	19.017
TiN	19.615*	19.616*	19.617*
Recommended torque	15 Ncm	20 Ncm	25 Ncm
On uniabutment®		19.018	
10 Pack.		19.018-P10	
TiN		19.618*	
Recommended torque		15 Ncm	

PRE-MILLED BLANK

Ø 10mm	Ti	61.023	61.024	61.025
Ø 14mm	Ti		62.024	62.025
Ø 14mm	CoCr		71.024	

CoCr BASE

		○		30.024	30.025
		○		31.024	31.025
On uniabutment®	20°	○	30.036		
	45°	○	30.037		

CASTABLE

		○		28.024	28.025
		○		29.024	29.025
On uniabutment®	20°	○	28.036		
On uniabutment®	45°	○	28.037		



INTERNAL HEX FD

compatible with
Xive®

The INTERNAL HEX FD connection will be available while stocks last.

- non-engaging
- engaging



HEALING ABUTMENT

	NP	RP	WP	5.5
	3.4	3.8	4.5	5.5
GH 3,0mm	20.036/3	20.037/3	20.038/3	
GH 4,0mm	20.036/4	20.037/4	20.038/4	
GH 5,0mm	20.036/5	20.037/5	20.038/5	



SCAN ABUTMENTS



	52.038	52.039	52.040	52.071	



EXTISA extender for 52.xxx.



52.xxx includes manual tool DTPEIPEEK.



TRANSFER

	17.038	17.039	17.040	17.071

Transfers include two screws (for open and closed tray).



Platform Colour Coded

DIGITAL ANALOGUE

Retention screw Hex 1,27 mm*

*Other retention screws available, see page 159



Platform Colour Coded

ANALOGUE

	NP	RP	WP	5.5
	3.4	3.8	4.5	5.5
	14.038/D	14.039/D	14.040/D	14.071/D
10 Pack.		14.039-P10		



TEMPORARY ABUTMENT

	24.038	24.039	24.040	
		25.038	25.039	25.040



DESSLoc®

GH 1,0mm	88.036/1	88.037/1
GH 2,0mm	88.036/2	88.037/2
GH 3,0mm	88.036/3	88.037/3
GH 4,0mm	88.036/4	88.037/4



TI-BASE		NP	RP	WP	5.5	
		3.4	3.8	4.5	5.5	
	GH 0,3mm	○	15.038	15.039	15.040	15.071
	GH 1,5mm	○	15.238	15.239	15.240	15.271
	GH 3,0mm	○	15.338	15.339	15.340	15.371
	GH 0,3mm	⬡	16.038	16.039	16.040	16.071
	GH 1,5mm	⬡	16.238	16.239	16.240	16.271
	GH 3,0mm	⬡	16.338	16.339	16.340	16.371
TI-BASE CASTABLES						
	5 Pack.	○	32.001-P5	32.001-P5	32.001-P5	32.001-P5
	5 Pack.	⬡	33.001-P5	33.001-P5	33.001-P5	33.001-P5



C-Base®		NP	RP	WP	5.5	
		3.4	3.8	4.5	5.5	
	GH 0,3mm	○	58.038	58.039		
	GH 0,6mm	○			58.040	58.071
	GH 1,5mm	○	58.038/2	58.039/2	58.040/2	58.071/2
	GH 3,0mm	○	58.038/3	58.039/3	58.040/3	58.071/3
	GH 0,3mm	⬡	59.038	59.039		
	GH 0,6mm	⬡			59.040	59.071
	GH 1,5mm	⬡	59.038/2	59.039/2	59.040/2	59.071/2
	GH 3,0mm	⬡	59.038/3	59.039/3	59.040/3	59.071/3

Includes screw, same as standard screw.

Libraries available for EXOCAD & 3Shape.



Torx® Screw ANGLEBase®	NP	RP	WP
(replacement screw)	19.438	19.438	19.438
Recommended torque	24 Ncm	24 Ncm	24 Ncm



ANGLEBase®						
		○	36.038	36.039	36.040	
		⬡	37.038	37.039	37.040	
PLASTIC SLEEVES FOR ANGLEBase®						
	5 Pack.	0°	33.100-P5	33.100-P5	33.100-P5	
	5 Pack.	10°	33.100-P5	33.101-P5	33.101-P5	
	5 Pack.	20°	33.100-P5	33.102-P5	33.102-P5	



Torx® BALL SCREWDRIVER	20mm	24mm	30mm	35mm
	DT20TB06	DT24TB06	DT30TB06	DT35TB06



ABUTMENTS				
	0°	13.038	13.039	13.040
	15°	22.038*	22.039*	22.040*
	25°		23.039*	

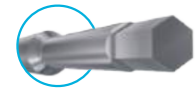

SCREW HEX 1,22mm

	NP	RP	WP	5.5
	3.4	3.8	4.5	5.5
	19.024	19.024	19.024	19.024
TiN	19.624*	19.624*	19.624*	19.624*
Recommended torque	24 Ncm	24 Ncm	24 Ncm	24 Ncm

PRE-MILLED BLANK

Ø	Material	NP	RP	WP	5.5
Ø 10mm	Ti	61.038	61.039	61.040	61.071
Ø 14mm	Ti		62.039	62.040	62.071
Ø 14mm	CoCr	71.038	71.039		71.071

CoCr BASE

○	30.038	30.039	30.040
⬡	31.038	31.039	31.040

CASTABLE

○	28.038	28.039	28.040
⬡	29.038	29.039	29.040



DESSLoc®

Superior resistance, better clinical results

DESS® overdenture system has a Zirconium Nitride coating, which offers improved strength with less plaque adhesion, improving clinical outcomes and reducing gingival inflammation.

- 100% compatible with the most widely used system.
- Reduces plaque adhesion.
- Reduces gingival inflammation.

Includes carrier for easy positioning.

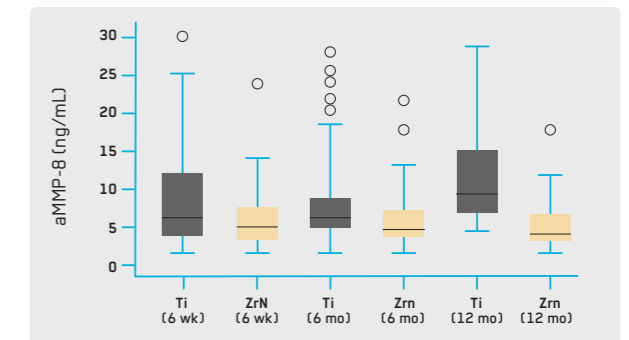

aMMP-8 values of peri-implant sulcus fluid in titanium (Ti) and zirconium nitride (ZrN) coated attachments at different times after prosthetic restoration. (Matrix Metalloproteinase-8 Levels in Peri-implant Sulcus Fluid Adjacent to Titanium and Zirconium Nitride Surface, Richard Meissen, MSc1 Mariana Mintcheva, MSc1 Lutz Netuschil, PhD Dr2, Int J Periodontics Restorative Dent 2014; 34:91-95. doi: 10.11607/prd.1504)

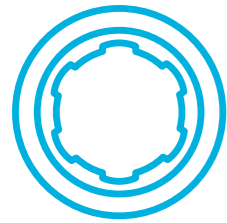

INTERNAL ANK

○ non-engaging
 ⬡ engaging

compatible with
 Dentsply Ankylos® C/X



HEALING ABUTMENT

GH 1,5mm	20.046/1
GH 2,5mm	20.046/3



SCAN ABUTMENTS



52.049



EXTISA extender for 52.xxx.



52.xxx includes manual tool DTPEIPEEK.



TRANSFER

GH 1,5mm	17.049
GH 2,5mm	17.250

Transfers include two screws (for open and closed tray).



Platform Colour Coded

DIGITAL ANALOGUE

Retention screw Hex 1,27 mm*	Ø 3,5	14.048/D
	Ø 4,5	14.049/D

*Other retention screws available, see page 159



Platform Colour Coded

ANALOGUE

Ø 3,5	14.048
10 Pack.	14.048-P10
Ø 4,5	14.049
10 Pack.	14.049-P10



TEMPORARY ABUTMENT

GH 1,5mm	○	24.048
GH 2,5mm	○	24.250
GH 1,5mm	⬡	25.048
GH 2,5mm	⬡	25.250







DESSLoc®

GH 2,0mm	88.046/2
GH 3,0mm	88.046/3
GH 4,0mm	88.046/4



TI-BASE

GH 1,5mm		15.050
GH 2,5mm		15.250
GH 1,5mm		16.050
GH 2,5mm		16.250







TI-BASE CASTABLES

5 Pack.		32.001-P5
5 Pack.		33.001-P5



C-Base®

GH 1,4mm		58.050
GH 2,5mm		58.050/2
GH 1,4mm		59.050
GH 2,5mm		59.050/2

Includes screw, same as standard screw.

Libraries available for EXOCAD & 3Shape.

Replacement Screw for C-Base®



Recommended torque

19.702

15 Ncm



ABUTMENTS

GH 1,5mm	0°	13.047
GH 2,5mm	0°	13.250
GH 1,5mm	15°	22.048*
GH 2,5mm	15°	22.250*
GH 1,5mm	25°	23.048*
GH 2,5mm	25°	23.250*



SCREW HEX 1,00mm

GH 1,5mm		19.048
TiN		19.648*
GH 2,5mm		19.050

Recommended torque

15 Ncm



PRE-MILLED BLANK

Ø 10mm	Ti	61.250
--------	----	--------



CoCr BASE

GH 1,5mm		30.050
GH 2,5mm		30.250
GH 1,5mm		31.050
GH 2,5mm		31.250



CASTABLE

GH 1,5mm		28.048
GH 2,5mm		28.250

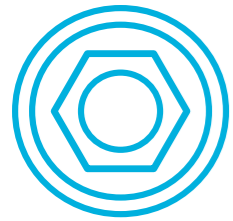

CONIC OSS

compatible with
Osstem® TS / HIOSSEN® ET

- non-engaging
- engaging



SCAN ABUTMENTS



	Mini	STD
	Mini	Regular
	52.072	52.073



EXTISA extender for 52.xxx.



52.xxx includes manual tool DTPEIPEEK.



TRANSFER

	17.072	17.073
--	--------	--------

Transfers include two screws (for open and closed tray).



DIGITAL ANALOGUE

Retention screw Hex 1,27 mm*

*Other retention screws available, see page 159

	14.072/D	14.073/D
--	----------	----------



Platform Colour Coded



ANALOGUE

	14.072	14.073
--	--------	--------



Platform Colour Coded



TEMPORARY ABUTMENT

-
-

	Mini	STD
	Mini	Regular
	24.072	24.073
	25.072	25.073



MULTI-UNIT ABUTMENTS

GH 1,5mm	0°	<input type="radio"/>	40.072/1	40.073/1
GH 2,5mm	0°	<input type="radio"/>	40.072/2	40.073/2
GH 3,5mm	0°	<input type="radio"/>	40.072/3	40.073/3
GH 2,5mm	17°	<input type="radio"/>	41.772/2*	41.773/2*
GH 3,5mm	17°	<input type="radio"/>	41.772/3*	41.773/3*
GH 3,5mm	30°	<input type="radio"/>	43.072/3*	43.073/3*
GH 4,5mm	30°	<input type="radio"/>	43.072/4*	43.073/4*

4.8
MULTI-UNIT PLATFORM



TI-BASE

GH 1,0mm	<input type="radio"/>	15.072	15.073
GH 3,0mm	<input type="radio"/>	15.372	15.373
GH 1,0mm	<input type="radio"/>	16.072	16.073
GH 3,0mm	<input type="radio"/>	16.372	16.373



TI-BASE CASTABLES

5 Pack.	<input type="radio"/>	32.001-P5	32.001-P5
5 Pack.	<input type="radio"/>	33.001-P5	33.001-P5



ANGLEBase®

		Mini	STD	
		Mini	Regular	
		36.072	36.073	
		37.072	37.073	
PLASTIC SLEEVES FOR ANGLEBase®				
	5 Pack.	0°	33.100-P5	33.100-P5
	5 Pack.	10°	33.101-P5	33.101-P5
	5 Pack.	20°	33.102-P5	33.102-P5



C-Base®

GH 1,0mm		58.072	58.073
GH 3,0mm		58.072/3*	58.073/3*
GH 1,0mm		59.072	59.073
GH 3,0mm		59.072/3	59.073/3

Includes screw, same as standard screw.

Libraries available for EXOCAD & 3Shape.



Torx® Screw ANGLEBase®

(replacement screw)	19.444	19.461
Recommended torque	20 Ncm	30 Ncm



Torx® BALL SCREWDRIVER	20mm	24mm	30mm	35mm
	DT20TB06	DT24TB06	DT30TB06	DT35TB06



SCREW HEX 1,22mm

		Mini	STD
		Mini	Regular
		19.072	19.073
	DLC	19.272*	19.273*
	TiN	19.672*	19.673*
Recommended torque		20 Ncm	30 Ncm

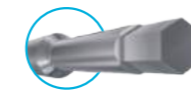

PRE-MILLED BLANK

Ø 10mm	Ti	61.072	61.073
Ø 14mm	Ti	62.072	62.073
Ø 14mm	CoCr	71.072	



CoCr BASE

	30.072	30.073
	31.072	31.073

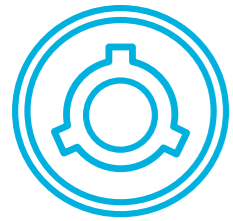

INTERNAL CAM

compatible with
Camlog®

- non-engaging
- engaging



HEALING ABUTMENT

	3.3	3.8	4.3	5.0
GH 3,0mm	20.065/3	20.066/3		
GH 4,0mm	20.065/4	20.066/4		
GH 5,0mm	20.065/5	20.066/5		



SCAN ABUTMENTS



	52.064	52.065	52.066	52.067



EXTISA extender for 52.xxx.



52.xxx includes manual tool DTPEIPEEK.



TRANSFER

	17.064	17.065	17.066	17.067

Transfers include two screws (for open and closed tray).



Platform Colour Coded

DIGITAL ANALOGUE

Retention screw Hex 1,27 mm*

*Other retention screws available, see page 159



Platform Colour Coded

ANALOGUE

	3.3	3.8	4.3	5.0
	14.064/D	14.065/D	14.066/D	14.067/D

	14.064	14.065	14.066	14.067
--	--------	--------	--------	--------



TEMPORARY ABUTMENT



24.065 24.066











25.065 25.066





DESSLoc®

GH 1,0mm	88.065/1	88.066/1
GH 2,0mm	88.065/2	88.066/2
GH 3,0mm	88.065/3	88.066/3
GH 4,0mm	88.065/4	88.066/4





TI-BASE		3.3	3.8	4.3	5.0
		3.3	3.8	4.3	5.0
GH 0,3mm			15.065	15.066	15.067
GH 0,5mm		15.064			
GH 1,5mm			15.265	15.266	
GH 3,0mm			15.365	15.366	
GH 0,3mm			16.065	16.066	16.067
GH 0,5mm		16.064			
GH 1,5mm			16.265	16.266	
GH 3,0mm			16.365	16.366	



TI-BASE CASTABLES					
5 Pack.		32.001-P5	32.001-P5	32.001-P5	32.001-P5
5 Pack.		33.001-P5	33.001-P5	33.001-P5	33.001-P5



ANGLEBase®				
			36.065	36.066
			37.065	37.066



PLASTIC SLEEVES FOR ANGLEBase®				
5 Pack.	0°		33.100-P5	33.100-P5
5 Pack.	10°		33.101-P5	33.101-P5
5 Pack.	20°		33.102-P5	33.102-P5



Torx® Screw ANGLEBase®				
(replacement screw)			19.444	19.444
Recommended torque			20 Ncm	20 Ncm



Torx® BALL SCREWDRIVER	20mm	24mm	30mm	35mm
	DT20TB06	DT24TB06	DT30TB06	DT35TB06



SCREW HEX 1,27mm	3.3	3.8	4.3	5.0
	3.3	3.8	4.3	5.0
	19.044	19.044	19.044	19.045
TiN	19.644*	19.644*	19.644*	19.645*
Recommended torque	20 Ncm	20 Ncm	20 Ncm	20 Ncm



PRE-MILLED BLANK					
Ø 10mm	Ti	61.064	61.065	61.066	61.067
Ø 14mm	Ti		62.065	62.066	62.067
Ø 14mm	CoCr	71.064		71.066	71.067



CoCr BASE				
			30.065	30.066
			31.065	31.066



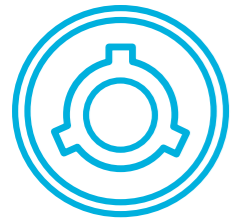

CASTABLE				
			28.065	28.066



INTERNAL CON

compatible with
Conelog®

-  non-engaging
-  engaging



SCAN ABUTMENTS



EXTISA extender for 52.xxx.



52.xxx includes manual tool DTPEIPEEK.

	NP	RP	WP
	3.3	3.8/4.3	5.0
	52.074	52.075	52.076



TRANSFER

	NP	RP	WP
	17.074	17.075	17.076

Transfers include two screws (for open and closed tray).



Platform Colour Coded

DIGITAL ANALOGUE

Retention screw Hex 1,27 mm*

*Other retention screws available, see page 159

	NP	RP	WP
	14.074/D	14.075/D	14.076/D



Platform Colour Coded

ANALOGUE

	NP	RP	WP
	14.074	14.075	14.076



TI-BASE

		NP	RP	WP
		3.3	3.8/4.3	5.0
GH 1,4mm		15.074*	15.075*	15.076*
GH 3,0mm		15.074/3*	15.075/3*	15.076/3*
GH 1,4mm		16.074*	16.075*	16.076*
GH 3,0mm		16.074/3*	16.075/3*	16.076/3*



TI-BASE CASTABLES

		NP	RP	WP
		3.3	3.8/4.3	5.0
5 Pack.		32.001-P5	32.001-P5	32.001-P5
5 Pack.		33.001-P5	33.001-P5	33.001-P5



ANGLEBase®

		NP	RP	WP
		3.3	3.8/4.3	5.0
		36.074*	36.075*	36.076*
		37.074*	37.075*	37.076*





PLASTIC SLEEVES FOR ANGLEBase®



		NP	RP	WP
		3.3	3.8/4.3	5.0
5 Pack.	0°	33.100-P5	33.100-P5	33.100-P5
5 Pack.	10°	33.101-P5	33.101-P5	33.101-P5
5 Pack.	20°	33.102-P5	33.102-P5	33.102-P5



C-Base®

		NP	RP	WP
		3.3	3.8/4.3	5.0
GH 1,0mm		58.074*	58.075*	58.076*
GH 2,1mm		58.074/2*	58.075/2*	58.076/2*
GH 1,0mm		59.074*	59.075*	59.076*
GH 2,1mm		59.074/2*	59.075/2*	59.076/2*

Includes screw, same as standard screw.

Libraries available for EXOCAD & 3Shape.

Replacement Screw for C-Base®



	19.052*	19.052*	19.053*
<i>Recommended torque</i>	<i>20 Ncm</i>	<i>20 Ncm</i>	<i>20 Ncm</i>

Torx® Screw ANGLEBase®



<i>(replacement screw)</i>	19.474*	19.474*	19.476*
<i>Recommended torque</i>	<i>20 Ncm</i>	<i>20 Ncm</i>	<i>20 Ncm</i>

Torx® BALL SCREWDRIVER



	20mm	24mm	30mm	35mm
	DT20TB06	DT24TB06	DT30TB06	DT35TB06



SCREW HEX 1,27mm

	NP	RP	WP
	3.3	3.8/4.3	5.0
	19.074*	19.074*	19.076*
TiN	19.674*	19.674*	19.676*
<i>Recommended torque</i>	<i>20 Ncm</i>	<i>20 Ncm</i>	<i>20 Ncm</i>

PRE-MILLED BLANK



Ø 10mm	Ti	61.074*	61.075*	61.076*
Ø 14mm	Ti	62.074*	62.075*	62.076*
Ø 14mm	CoCr	71.074*	71.075*	71.076*



INTERNAL HEX BH

compatible with
BioHorizons® internal

○ non-engaging

⬡ engaging



HEALING ABUTMENT

	3.0	NP	RP	WP
	3.0	3.5	4.5	5.7
GH 3,0mm		20.087/3	20.088/3	20.089/3
GH 4,0mm		20.087/4	20.088/4	20.089/4
GH 5,0mm		20.087/5	20.088/5	20.089/5



SCAN ABUTMENTS



	52.099	52.087	52.088	52.089
--	--------	--------	--------	--------



EXTISA extender for 52.xxx.



52.xxx includes manual tool DTPEIPEEK.



TRANSFER

	17.087	17.088	17.089
--	--------	--------	--------

Transfers include two screws (for open and closed tray).



Platform Colour Coded

DIGITAL ANALOGUE

Retention screw Hex 1,27 mm*	14.099/D	14.087/D	14.088/D	14.089/D
------------------------------	----------	----------	----------	----------

*Other retention screws available, see page 159



Platform Colour Coded

ANALOGUE

	3.0	NP	RP	WP
	3.0	3.5	4.5	5.7
	14.099	14.087	14.088	14.089



DESSLoc®

GH 1,0mm	88.087/1	88.088/1
GH 2,5mm	88.087/2	88.088/2
GH 3,5mm	88.087/3	88.088/3
GH 4,5mm	88.087/4	88.088/4
GH 5,5mm	88.087/5	



TI-BASE

GH 0,3mm	○	15.088	15.089
GH 0,8mm	○	15.087	
GH 0,3mm	⬡	16.088	16.089
GH 0,8mm	⬡	16.087	











TI-BASE CASTABLES

5 Pack.	○	32.001-P5	32.001-P5	32.001-P5
5 Pack.	⬡	33.001-P5	33.001-P5	33.001-P5



MULTI-UNIT ABUTMENTS

			3.0	NP	RP	WP
			3.0	3.5	4.5	5.7
GH 1,0mm	0°			40.087/1	40.088/1	
GH 2,0mm	0°			40.087/2	40.088/2	
GH 3,0mm	0°			40.087/3	40.088/3	
GH 4,0mm	0°			40.087/4		
GH 5,0mm	0°			40.087/5		
GH 2,5mm	17°			41.787/2*	41.788/2*	
GH 3,5mm	17°			41.787/3*	41.788/3*	
GH 3,5mm	30°			43.087/3*	43.088/3*	
GH 4,5mm	30°			43.087/4*	43.088/4*	

4.8
MULTI-UNIT PLATFORM



ANGLEBase®



			36.087	36.088	36.089
			37.087	37.088	37.089

PLASTIC SLEEVES FOR ANGLEBase®

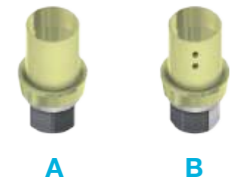
	5 Pack.	0°	33.100-P5	33.100-P5	33.100-P5
	5 Pack.	10°	33.101-P5	33.101-P5	33.101-P5
	5 Pack.	20°	33.102-P5	33.102-P5	33.102-P5







ELLIPTIBase®

A corner		56.099
B flat		57.099



C-Base®

		3.0	NP	RP	WP
		3.0	3.5	4.5	5.7
GH 0,5mm			58.087	58.088	58.089
GH 3,0mm			58.087/3	58.088/3	58.089/3
GH 0,5mm			59.087	59.088	59.089
GH 3,0mm			59.087/3	59.088/3	59.089/3

Includes screw, same as standard screw.

Libraries available for EXOCAD & 3Shape.

Torx® Screw ANGLEBase® & ELLIPTIBase®

(replacement screw)	19.400	19.417	19.417	19.417
Recommended torque	30 Ncm	30 Ncm	30 Ncm	30 Ncm



Torx® BALL SCREWDRIVER

	20mm	24mm	30mm	35mm
	DT20TB06	DT24TB06	DT30TB06	DT35TB06



SCREW HEX 1,27mm

	19.043	19.043	19.043	19.043
TiN	19.643*	19.643*	19.643*	19.643*
Recommended torque	30 Ncm	30 Ncm	30 Ncm	30 Ncm



PRE-MILLED BLANK

Ø 10mm	Ti	61.099	61.087	61.088	61.089
Ø 14mm	Ti			62.088	62.089





EXTERNAL HEX BH

compatible with
BioHorizons® External

○ non-engaging
⬡ engaging



HEALING ABUTMENT

	NP	RP	WP
	3.7	4.2	5.2
GH 3,0mm	20.020/3*	20.021/3*	20.022/3*
GH 4,0mm	20.020/4*	20.021/4*	20.022/4*
GH 5,0mm	20.020/5*	20.021/5*	20.022/5*



SCAN ABUTMENTS



	52.020	52.021	52.022
--	--------	--------	--------

 EXTISA extender for 52.xxx.  52.xxx includes manual tool DTPEIPEEK.



TRANSFER

	17.020	17.021	17.022
--	--------	--------	--------

Transfers include two screws (for open and closed tray).



 Platform Colour Coded

DIGITAL ANALOGUE

Retention screw Hex 1,27 mm*

*Other retention screws available, see page 159



 Platform Colour Coded

ANALOGUE

	NP	RP	WP
	3.7	4.2	5.2
	14.020/D	14.021/D	14.022/D
	14.020	14.021	14.022



TEMPORARY ABUTMENT

○	24.020*	24.021*	24.022*
⬡	25.020*	25.021*	25.022*



TI-BASE

GH 0,3mm	○	15.051*	15.052*	15.053*
GH 0,3mm	⬡	16.051*	16.052*	16.053*



TI-BASE CASTABLES

5 Pack.	○	32.001-P5	32.001-P5	32.003-P5
5 Pack.	⬡	33.001-P5	33.001-P5	33.003-P5



ABUTMENTS

	NP	RP	WP
0°	13.020*	13.021*	13.022*
15°	22.020*	22.021*	



SCREW HEX 1,27mm

	19.013*	19.014*	19.014*
10 Pack.		19.014-P10*	19.014-P10*
Recommended torque	30 Ncm	30 Ncm	30 Ncm





PRE-MILLED BLANK

Ø 10mm	Ti	61.020*	61.021*	61.022*
Ø 14mm	Ti	62.020*	62.021*	62.022*
Ø 14mm	CoCr	71.020*	71.021*	71.022*



CASTABLE

	28.020	28.021	28.022
	29.020	29.021	29.022

Your design, our precision

PRE-MILLED

Mill your design with the precision of the DESS® connections. Our range of blank pre-milled is available for the most popular implant connections in the world.

- 32 compatibilities
- Titanium Grade 5 ELI Ø 10mm 14mm
- Micromelt CoCr Ø 14mm
- Total millable length 20mm
- Minimal gingival transition (0,3mm)





INTERNAL HEX MI

compatible with
Mis® Seven

- non-engaging
- engaging



HEALING ABUTMENT

	NP	SP	WP	Multi-Unit
	3.3	3.75-4.2	5.0-6.0	4.8
GH 3,0mm		20.095/3*	20.096/3*	
GH 4,0mm		20.095/4*	20.096/4*	
GH 5,0mm		20.095/5*	20.096/5*	



SCAN ABUTMENTS



EXTISA extender for 52.xxx.



52.xxx includes manual tool DTPEIPEEK.

52.056	52.095	52.096	52.085
--------	--------	--------	--------



TRANSFER

17.056	17.095	17.096
--------	--------	--------

Transfers include two screws (for open and closed tray).

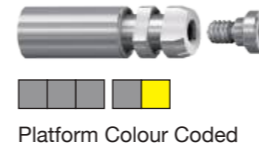

Platform Colour Coded

DIGITAL ANALOGUE

Retention screw Hex 1,27 mm*

*Other retention screws available, see page 159



Platform Colour Coded

ANALOGUE

10 Pack.

	NP	SP	WP	Multi-Unit
	3.3	3.75-4.2	5.0-6.0	4.8
	14.056/D	14.095/D	14.096/D	14.007/D ¹ 14.085/D ²
		14.095	14.096	14.007 ¹ 14.085 ²
		14.095-P10		14.007-P10
		¹ Standard Multi-Unit		² MIS® Multi-Unit



TEMPORARY ABUTMENT

-
-









24.095*	24.096*
25.095*	25.096*





DESSLoc®

GH 1,0mm	88.095/1*	88.096/1*
GH 2,5mm	88.095/2*	88.096/2*
GH 3,5mm	88.095/3*	88.096/3*
GH 4,5mm	88.095/4*	88.096/4*
GH 5,5mm	88.095/5*	











TI-BASE			NP	SP	WP	Multi-Unit
			3.3	3.75-4.2	5.0-6.0	4.8
	GH 0,3mm				15.096*	15.085* <small>MS</small>
	GH 0,8mm		15.056*	15.095*		
	GH 1,5mm		15.256*	15.295*	15.296*	
	GH 3,0mm		15.356*	15.395*	15.396*	
	GH 0,3mm				16.096*	
	GH 0,8mm		16.056*	16.095*		
	GH 1,5mm		16.256*	16.295*	16.296*	
	GH 3,0mm		16.356*	16.395*	16.396*	



TI-BASE CASTABLES						
	5 Pack.		32.001-P5	32.001-P5	32.001-P5	32.001-P5
	5 Pack.		33.001-P5	33.001-P5	33.001-P5	33.001-P5





MULTI-UNIT ABUTMENTS

GH 1,0mm	0°			40.095/1*	40.096/1*
GH 2,0mm	0°			40.095/2*	40.096/2*
GH 3,0mm	0°			40.095/3*	40.096/3*
GH 4,0mm	0°			40.095/4*	
GH 5,0mm	0°			40.095/5	
GH 2,5mm	17°			41.795/2*	41.796/2*
GH 3,5mm	17°			41.795/3*	41.796/3*
GH 3,5mm	30°			43.095/3	43.096/3
GH 4,5mm	30°			43.095/4	43.096/4

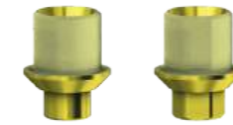
4.8
MULTI-UNIT PLATFORM



ANGLEBase®

		NP	SP	WP	Multi-Unit
		3.3	3.75-4.2	5.0-6.0	4.8
			36.095*	36.096*	
			37.095*	37.096*	

PLASTIC SLEEVES FOR ANGLEBase®



5 Pack.	0°	33.100-P5	33.100-P5
5 Pack.	10°	33.101-P5	33.101-P5
5 Pack.	20°	33.102-P5	33.102-P5



Torx® Screw ANGLEBase®

(replacement screw)	19.417	19.417
Recommended torque	30 Ncm	30 Ncm



Torx® BALL SCREWDRIVER



	20mm	24mm	30mm	35mm
	DT20TB06	DT24TB06	DT30TB06	DT35TB06



ABUTMENTS

0°	13.095*	13.096*
15°	22.095*	22.096*
25°	23.095*	23.096*





	NP	SP	WP	Multi-Unit
SCREW HEX 1,27mm	3.3	3.75-4.2	5.0-6.0	4.8
	19.056*	19.081*	19.081*	19.110 
TiN	19.656*	19.681*	19.681*	
Recommended torque	30 Ncm	30 Ncm	30 Ncm	30 Ncm
				19.085* 
TiN				19.685* 
Recommended torque				15 Ncm





PRE-MILLED BLANK				
Ø 10mm	Ti	61.056*	61.095*	61.096*
Ø 14mm	CoCr			71.096*



CoCr BASE				
		30.056*	30.095*	30.096*
		31.056*	31.095*	31.096*



CASTABLE				
		28.056	28.095	28.096
		29.056	29.095	29.096



ELLIPTIBase

FOR NARROW INTERDENTAL SPACES

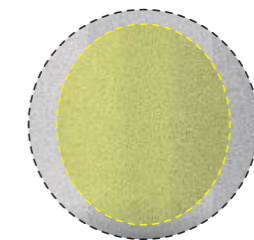
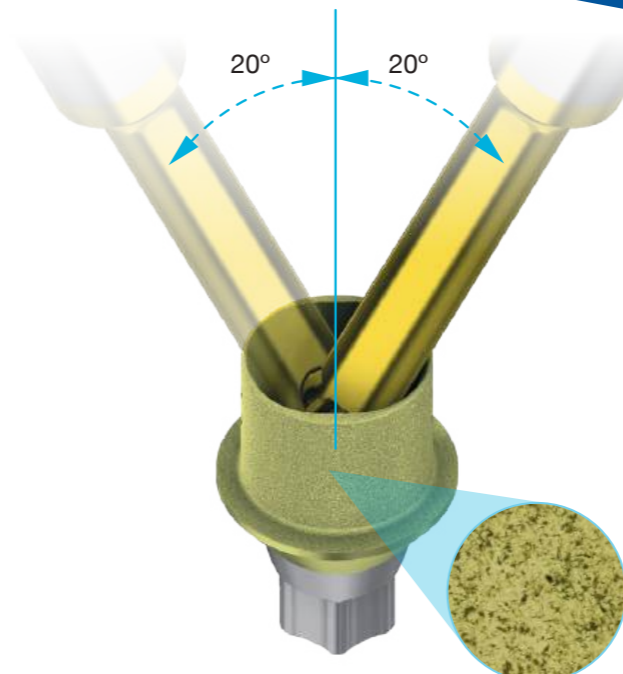
- Better aesthetic results.
- SelectGrip® surface treatment.
- 22% smaller than a standard Ti-Base.
- 20° angulation.
- PerioCoat® surface treatment (ZrN) coating.



Footprint

-  ELLIPTIBase®
-  Ti-Base

The 22% size reduction achieved in ELLIPTIBase® design allows for more space for restoration.

SelectGrip®: surface treatment that improves retention by up to 500%.

*Microscopic view

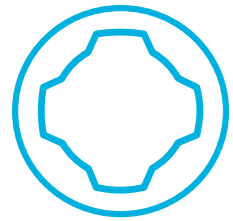

CONIC MC

compatible with
Mis® C1 internal

-  non-engaging
-  engaging



SCAN ABUTMENTS

	NP	SP	WP	Multi-Unit
				4.8
	52.081	52.082	52.083	52.085 <small>MIS</small>



EXTISA extender for 52.xxx.



52.xxx includes manual tool DTPEIPEEK.



TRANSFER

	NP	SP	WP	Multi-Unit
	17.081	17.082	17.083	

Transfers include two screws (for open and closed tray).



DIGITAL ANALOGUE



Platform Colour Coded

	NP	SP	WP	Multi-Unit
Retention screw Hex 1,27 mm*	14.081/D	14.082/D	14.083/D	14.007/D ¹ 14.085/D ²

*Other retention screws available, see page 159

¹ Standard Multi-Unit

² MIS® Multi-Unit



ANALOGUE



Platform Colour Coded

	NP	SP	WP	Multi-Unit
	14.081	14.082	14.083	14.007 ¹ 14.085 ²

¹ Standard Multi-Unit

² MIS® Multi-Unit



TI-BASE

	NP	SP	WP	Multi-Unit
				4.8
GH 0,3mm				15.085* <small>MIS</small>
GH 1,0mm	15.081*	15.082*	15.083*	
GH 1,0mm	16.081*	16.082*	16.083*	



TI-BASE CASTABLES

	NP	SP	WP	Multi-Unit
5 Pack.	32.001-P5	32.001-P5	32.001-P5	32.007-P5
5 Pack.	33.001-P5	33.001-P5	33.001-P5	



SCREW HEX 1,27mm

	NP	SP	WP	Multi-Unit
	19.056*	19.081*	19.081*	19.085* <small>MIS</small>
TiN	19.656*	19.681*	19.681*	19.685* <small>MIS</small>

Recommended torque

30 Ncm	30 Ncm	30 Ncm	25 Ncm
--------	--------	--------	--------



PRE-MILLED BLANK

	NP	SP	WP	Multi-Unit
Ø 10mm Ti	61.081*	61.082*	61.083*	



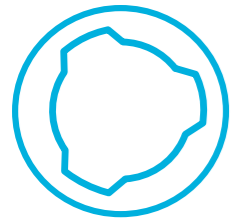

CONIC MV

compatible with
Mis® V3

-  non-engaging
-  engaging



SCAN ABUTMENTS



NP	SP	Multi-Unit
		4.8

52.084	52.082	52.085 <small>MIS</small>
--------	--------	---------------------------



EXTISA extender for 52.xxx.



52.xxx includes manual tool DTPEIPEEK.



TRANSFER

17.084	17.082
--------	--------

Transfers include two screws (for open and closed tray).



DIGITAL ANALOGUE



Platform Colour Coded

Retention screw Hex 1,27 mm*

14.084/D	14.082/D	14.007/D ¹
----------	----------	-----------------------

14.085/D ²

*Other retention screws available, see page 159

¹ Standard Multi-Unit

² MIS® Multi-Unit



ANALOGUE



Platform Colour Coded

14.084	14.082	14.007 ¹
--------	--------	---------------------

14.085 ²

¹ Standard Multi-Unit

² MIS® Multi-Unit



TI-BASE

NP	SP	Multi-Unit
		4.8

GH 0,3mm			15.085* <small>MIS</small>
----------	---	--	----------------------------

GH 1,0mm		15.084*	15.082*
----------	---	---------	---------

GH 1,0mm		16.084*	16.082*
----------	---	---------	---------



TI-BASE CASTABLES

5 Pack.		32.001-P5	32.001-P5	32.007-P5
---------	---	-----------	-----------	-----------

5 Pack.		33.001-P5	33.001-P5	
---------	---	-----------	-----------	--



SCREW HEX 1,27mm

19.056*	19.081*
---------	---------

19.085*

TiN	19.656*	19.681*
-----	---------	---------

TiN		19.685*
-----	--	---------

Recommended torque

30 Ncm

30 Ncm

25 Ncm



PRE-MILLED BLANK

Ø 10mm	Ti	61.084*	61.082*
--------	----	---------	---------





CONIC ANYR

compatible with
Megagen AnyRidge®

- non-engaging
- engaging



SCAN ABUTMENTS



52.057



EXTISA extender for 52.xxx.



52.xxx includes manual tool DTPEIPEEK.



TRANSFER

17.057

Transfers include two screws (for open and closed tray).



DIGITAL ANALOGUE

Retention screw Hex 1,27 mm*

14.057/D

*Other retention screws available, see page 159

Platform Colour Coded



ANALOGUE

14.057

Platform Colour Coded



TI-BASE

GH 2,0mm		15.057
GH 3,0mm		15.357
GH 2,0mm		16.057
GH 3,0mm		16.357



TI-BASE CASTABLES

5 Pack.		32.001-P5
5 Pack.		33.001-P5



ANGLEBase®

	36.057
	37.057

PLASTIC SLEEVES FOR ANGLEBase®



5 Pack.	0°	33.100-P5
5 Pack.	10°	33.101-P5
5 Pack.	20°	33.102-P5



Torx® Screw ANGLEBase®

(replacement screw)

19.460

Recommended torque

35 Ncm



Torx® BALL SCREWDRIVER

	20mm	24mm	30mm	35mm
	DT20TB06	DT24TB06	DT30TB06	DT35TB06



SCREW HEX 1,20mm

		19.057
	TiN	19.657*
Recommended torque		35 Ncm



PRE-MILLED BLANK

Ø 10mm	Ti	61.057
Ø 14mm	CoCr	71.057

periocoat® Zirconium Nitride



Less biofilm genesis on the surface

With less biofilm and plaque, there will be less quantity and quality of bacteria that can cause soft tissue inflammation.



Increased collagen stability

ZrN creates less of an inflammatory burden and collagen degradation in the gingival tissue as evidenced by less aMMP8 biomarker in the gingival fluid.



Surface is more resistant to corrosion

Dental plaque produces acid that will corrode the surface and increase roughness. ZrN is harder and has a smaller friction coefficient, which makes it more resistant to corrosion.



Increased adhesion of fibroblasts

A higher adhesion of fibroblasts locks the path between the surface and soft tissue preventing bacteria to enter the gingival margin.



Six times harder than Titanium Oxide

Will not scratch as easily when cleaned using cures, ultrasound or other instruments.



ZrN has a warm gold hue

A warmer goldish hue has aesthetic advantages compared to the titanium grey.

periocoat®

- Less inflammation.
- Less plaque adhesion.
- Higher corrosion resistance.
- Easier to clean.
- 6x harder than Titanium Oxide.



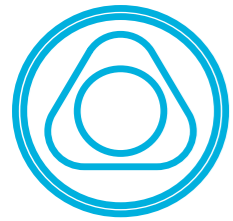

CONIC AXIO

compatible with
Anthogyr AXIOM® BL

-  non-engaging
-  engaging



SCAN ABUTMENTS



52.077



EXTISA extender for 52.xxx.



52.xxx includes manual tool DTPEIPEEK.



TRANSFER

17.077

Transfers include two screws (for open and closed tray).



DIGITAL ANALOGUE

Retention screw Hex 1,27 mm*

14.077/D

Platform Colour Coded

*Other retention screws available, see page 159



ANALOGUE

14.077

Platform Colour Coded



TI-BASE

GH 2,9mm		15.077*
----------	---	---------

GH 2,9mm		16.077*
----------	---	---------

TI-BASE CASTABLES



5 Pack.		32.001-P5
---------	---	-----------

5 Pack.		33.001-P5
---------	---	-----------



SCREW HEX 1,18mm

19.077*

TiN	19.677*
-----	---------

Recommended torque	25 Ncm
--------------------	--------

On Abutment®	19.062*
--------------	---------

TiN	19.662*
-----	---------

Recommended torque	15 Ncm
--------------------	--------



PRE-MILLED BLANK

Ø 10mm	Ti	61.077*
--------	----	---------





SCAN ABUTMENTS



52.080



EXTISA extender for 52.xxx.



52.xxx includes manual tool DTPEIPEEK.



TRANSFER

17.080

Transfers include two screws (for open and closed tray).



DIGITAL ANALOGUE

Retention screw Hex 1,27 mm*

14.080/D

Platform Colour Coded

*Other retention screws available, see page 159



ANALOGUE

14.080

Platform Colour Coded



TI-BASE



15.080*



16.080*



TI-BASE CASTABLES

5 Pack.



32.001-P5

5 Pack.



33.001-P5



ANGLEBase®

GH 2,2mm



36.080*

GH 0,9mm



36.180*

GH 2,2mm



37.080*

GH 0,9mm



37.180*

PLASTIC SLEEVES FOR ANGLEBase®



5 Pack.

0°

33.100-P5

5 Pack.

10°

33.101-P5

5 Pack.

20°

33.102-P5



Torx® Screw ANGLEBase®

2,2mm

19.444

(replacement screw)

0,9mm

19.443

Recommended torque

30 Ncm

Torx® BALL SCREWDRIVER

20mm

24mm

30mm

35mm

DT20TB06

DT24TB06

DT30TB06

DT35TB06





SCREW HEX 1,40mm

		19.080*
	TiN	19.680*
<i>Recommended torque</i>		30 Ncm



PRE-MILLED BLANK

Ø 10mm	Ti	61.080*
Ø 14mm	Ti	62.080*
Ø 14mm	CoCr	71.080*

The importance of a precise image

Our revolutionary intraoral scan abutment, co-designed with Exocad®, has been carefully created to produce the most precise image. Intraoral scan abutment, manufactured in titanium, allows for Rx control and includes ZrN coating to reduce glitter effect.

1. NO SCREW HOLE
(No distortion on scan)
2. ORIENTATION ON HIGHER POSITION
(Maximum visibility)
3. MANUFACTURED IN TITANIUM
(Extremely durable)
4. INCLUDES MANUAL TOOL DTPEIPEEK.





CONIC INK
compatible with
GlobalD IN-KONE®

-  non-engaging
-  engaging



**SCAN
ABUTMENTS**



52.086



EXTISA extender for 52.xxx.



52.xxx includes manual tool DTPEIPEEK.



TRANSFER

17.086

Transfers include two screws (for open and closed tray).



**DIGITAL
ANALOGUE**

Retention screw Hex 1,27 mm*

14.086/D

Platform Colour Coded

*Other retention screws available, see page 159



ANALOGUE

14.086

Platform Colour Coded



TI-BASE



15.086*



16.086*



TI-BASE CASTABLES

5 Pack.



32.001-P5

5 Pack.



33.001-P5



SCREW HEX 1,22mm

		19.086*
	TiN	19.686*
On Abutment®	0°	19.035*
	17° / 30°	19.036*
TiN	0°	19.635*
TiN	17° / 30°	19.636*



Recommended torque

15 Ncm



CONIC DENT

compatible with
Dentium Superline™ & Implantium®

-  non-engaging
-  engaging



SCAN ABUTMENTS



52.090



EXTISA extender for 52.xxx.



52.xxx includes manual tool DTPEIPEEK.



TRANSFER

17.090

Transfers include two screws (for open and closed tray).



 Platform Colour Coded

DIGITAL ANALOGUE

Retention screw Hex 1,27 mm*

*Other retention screws available, see page 159

14.090/D









Platform Colour Coded

ANALOGUE



14.090

TI-BASE

GH 0,9mm		15.090*
GH 1,5mm		15.190* (15.090/2*)
GH 3,0mm		15.390* (15.090/3*)
GH 0,9mm		16.090*
GH 1,5mm		16.190* (16.090/2*)
GH 3,0mm		16.390* (16.090/3*)



TI-BASE CASTABLES

5 Pack.		32.001-P5
5 Pack.		33.001-P5



MULTI-UNIT ABUTMENTS

		RP				
		3.6	3.8	4.0	4.5	5.0
GH 1,5mm	0°	○				40.090/1
GH 2,5mm	0°	○				40.090/2
GH 3,5mm	0°	○				40.090/3
GH 2,5mm	17°	⬡				41.790/2*
GH 3,5mm	17°	⬡				41.790/3*
GH 2,5mm	30°	⬡				43.090/2*
GH 3,5mm	30°	⬡				43.090/3*



ANGLEBase®

		○				36.090*
		⬡				37.090*

PLASTIC SLEEVES FOR ANGLEBase®

	5 Pack.	0°				33.100-P5
	5 Pack.	10°				33.101-P5
	5 Pack.	20°				33.102-P5

Torx® Screw ANGLEBase®

	(replacement screw)					19.405
	Recommended torque					30 Ncm

Torx® BALL SCREWDRIVER



	20mm	24mm	30mm	35mm
	DT20TB06	DT24TB06	DT30TB06	DT35TB06



SCREW HEX 1,28mm

		RP				
		3.6	3.8	4.0	4.5	5.0
	TiN					19.090*
	TiN					19.690*
	Recommended torque					30 Ncm
	On Abutment®					19.066*
	TiN					19.666*
	Recommended torque					10 Ncm



PRE-MILLED BLANK

Ø 10mm	Ti					61.090*
Ø 14mm	Ti					62.090*
Ø 14mm	CoCr					71.090*



CoCr BASE

	○					30.090*
	⬡					31.090*



CASTABLE

	○					28.090
	⬡					29.090

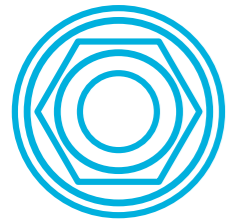

INTERNAL SEM

compatible with
Bego Semados®

-  non-engaging
-  engaging



SCAN ABUTMENTS

	3.25/3.75	4.1	4.5	5.5
--	-----------	-----	-----	-----



	52.091	52.092	52.093	52.094
--	--------	--------	--------	--------



EXTISA extender for 52.xxx.



52.xxx includes manual tool DTPEIPEEK.



TRANSFER

	17.091	17.092	17.093	17.094
--	--------	--------	--------	--------

Transfers include two screws (for open and closed tray).



DIGITAL ANALOGUE



Platform Colour Coded

Retention screw Hex 1,27 mm*	14.091/D	14.092/D	14.093/D	14.094/D
------------------------------	----------	----------	----------	----------

*Other retention screws available, see page 159



ANALOGUE



Platform Colour Coded

	14.091	14.092	14.093	14.094
--	--------	--------	--------	--------



TI-BASE

	3.25/3.75	4.1	4.5	5.5
--	-----------	-----	-----	-----

GH 0,7mm			15.091*	15.094*
GH 0,9mm			15.091*	
GH 1,1mm		15.091*		
GH 0,7mm			16.091*	16.094*
GH 0,9mm			16.091*	
GH 1,1mm		16.091*		



TI-BASE CASTABLES

5 Pack.		32.001-P5	32.001-P5	32.001-P5	32.001-P5
5 Pack.		33.001-P5	33.001-P5	33.001-P5	33.001-P5



SCREW HEX 1,27mm

	19.091*	19.091*	19.091*	19.091*
TiN	19.691*	19.691*	19.691*	19.691*

Recommended torque 30 Ncm 30 Ncm 30 Ncm 30 Ncm



PRE-MILLED BLANK

Ø 10mm	Ti	61.091*	61.092*	61.093*	61.094*
Ø 14mm	Ti				62.094*
Ø 14mm	CoCr				71.094*





CONIC BIO
compatible with
Biotech KONTACT®

○ non-engaging
⊛ engaging



SCAN ABUTMENTS



NP RP

52.078



EXTISA extender for 52.xxx.



52.xxx includes manual tool DTPEIPEEK.



TRANSFER

17.078

Transfers include two screws (for open and closed tray).



Platform Colour Coded

DIGITAL ANALOGUE

Retention screw Hex 1,27 mm*

14.078/D

*Other retention screws available, see page 159



Platform Colour Coded

ANALOGUE

14.078



TI-BASE

NP RP



15.078*



16.078*



TI-BASE CASTABLES

5 Pack.



32.001-P5

5 Pack.



33.001-P5



SCREW HEX 1,22mm

TiN

19.078*

19.063*

19.064*

19.678*

19.663*

19.664*

Recommended torque

20 Ncm

20 Ncm

20 Ncm



PRE-MILLED BLANK

Ø 10mm Ti

61.078*





INTERNAL BT

compatible with
BTI®

-  non-engaging
-  engaging



SCAN ABUTMENTS



4.1 MULTI IM®

52.079



EXTISA extender for 52.xxx.



52.xxx includes manual tool DTPEIPEEK.



TRANSFER

17.079

Transfers include two screws (for open and closed tray).



DIGITAL ANALOGUE



Platform Colour Coded

Retention screw Hex 1,27 mm*

*Other retention screws available, see page 159

14.079/D



ANALOGUE

4.1 MULTI IM®

14.079



Platform Colour Coded



TI-BASE



15.079*



16.079*



TI-BASE CASTABLES

5 Pack.



32.001-P5

5 Pack.



33.001-P5



SCREW HEX 1,22mm

19.079*

19.065

TiN

19.679*

19.665*

Recommended torque

35 Ncm

10 Ncm



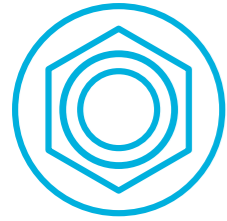

EXTERNAL HEX PH

compatible with
PHIBO® TSH®

-  non-engaging
-  engaging



SCAN ABUTMENTS



EXTISA extender for 52.xxx.



52.xxx includes manual tool DTPEIPEEK.

	NP	SP	WP
	S2	S3-S4	S5

	52.030	52.031	52.032
--	--------	--------	--------



TRANSFER

	17.030	17.031	17.032
--	--------	--------	--------

Transfers include two screws (for open and closed tray).



DIGITAL ANALOGUE

Retention screw Hex 1,27 mm*

*Other retention screws available, see page 159

	14.030/D	14.031/D	14.032/D
--	----------	----------	----------

Platform Colour Coded









ANALOGUE

	14.030	14.031	14.032
--	--------	--------	--------

Platform Colour Coded

ANGLEBase®

	NP	SP	WP
	S2	S3-S4	S5

	36.030*	36.031*	36.032*
	36.030/2*	36.031/2*	36.032/2*
	36.030/3*	36.031/3*	36.032/3*
	37.030*	37.031*	37.032*
	37.030/2*	37.031/2*	37.032/2*
	37.030/3*	37.031/3*	37.032/3*



PLASTIC SLEEVES FOR ANGLEBase®



5 Pack.	0°	33.100-P5	33.100-P5	33.100-P5
5 Pack.	10°	33.101-P5	33.101-P5	33.101-P5
5 Pack.	20°	33.102-P5	33.102-P5	33.102-P5

Torx® Screw ANGLEBase®

(replacement screw)

Recommended torque

19.403*	19.402	19.402
---------	--------	--------

35 Ncm	35 Ncm	35 Ncm
--------	--------	--------



Torx® BALL SCREWDRIVER

	20mm	24mm	30mm	35mm
	DT20TB06	DT24TB06	DT30TB06	DT35TB06



MULTI-UNIT CONNECTION



○ non-engaging

HEALING ABUTMENT		RP 4.8	MULTI-UNIT	WP 6
------------------	--	-----------	------------	---------

Uni Grip	○	20.100		20.054
Hex 1,20mm	○	20.100H120		
Hex 1,22mm	○	20.100H122		
Hex 1,27mm	○	20.100H127		
Torx® Ball	○	20.100TB*		



SCAN ABUTMENTS

		50.007		
		52.007		52.047

 EXTISA extender for 52.xxx.

 52.xxx includes manual tool DTPEIPEEK.

TRANSFER

		17.007		17.050
5,0mm		17.507		
5,0mm	4 Pack.	17.507-P4		
8,0mm		17.807		
8,0mm	4 Pack.	17.807-P4		



DIGITAL ANALOGUE

Retention screw Hex 1,27 mm*		14.007/D		14.047/D
------------------------------	--	----------	--	----------

*Other retention screws available, see page 159



 Platform Colour Coded





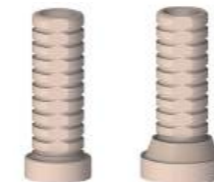

 Platform Colour Coded







ANALOGUE

10 Pack.







TEMPORARY ABUTMENT

			RP 4.8	MULTI-UNIT	WP 6
Uni Grip	 ○		24.007		24.030
Hex 1,20mm	 ○		24.007H120 19.055		
Hex 1,22mm	 ○		24.007H122 19.065		
Hex 1,27mm	 ○		24.007H127 19.110		
Torx®	 ○		24.007TB* 19.306		

TEMPORARY ABUTMENT PEEK

Uni Grip	 ○		25.707		25.754
Hex 1,20mm	 ○		24.757* 19.055		
Hex 1,22mm	 ○		24.767* 19.065		
Hex 1,27mm	 ○		24.777* 19.110		
Torx®	 ○		24.787* 19.306		

TI-BASE

6,0mm	Uni Grip	 ○	15.007		15.054
6,0mm	Uni Grip	 ○	15.007-P10		
6,0mm	Hex 1,20mm	 ○	15.007H120 19.055		
6,0mm	Hex 1,22mm	 ○	15.007H122 19.065		
6,0mm	Hex 1,27mm	 ○	15.007H127 19.110		
6,0mm	Torx®	 ○	15.007TB* 19.306		
8,0mm	Uni Grip	 ○	15.007/8		

TI-BASE CASTABLES

5 Pack.	○		32.007-P5		32.054-P5
5 Pack.	○		32.007/8-P5		





			RP 4.8	WP 6
ANGLEBase®				
		○	36.007	36.054
10 Pack.		○	36.007-P10	

PLASTIC SLEEVES FOR ANGLEBase®



5 Pack.	0°		33.700-P5	
5 Pack.	10°		33.701-P5	
5 Pack.	20°		33.702-P5	

Torx® Screw ANGLEBase®



(replacement screw)			19.306	19.331*
Recommended torque			15 Ncm	15 Ncm

Torx® BALL SCREWDRIVER



	20mm	24mm	30mm	35mm
	DT20TB06	DT24TB06	DT30TB06	DT35TB06

SCREWS FOR SUPERSTRUCTURES

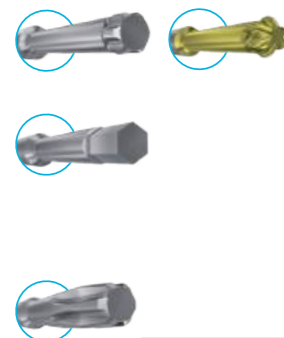

10 Pack.		Torx®	19.069-P10	
10 Pack.	DLC	Torx®	19.269-P10	
10 Pack.		Hex 1,20mm	19.093-P10	
10 Pack.		Hex 1,22mm	19.094-P10	
10 Pack.		Hex 1,27mm	19.095-P10	
10 Pack.		UG	19.096-P10	

Recommended torque 20 Ncm



SCREW UG

			RP 4.8	WP 6
SCREW UG				
10 Pack.			19.006	19.031
			19.006-P10	
	DLC		19.206	19.231
	TiN		19.606*	19.631*

Hex 1,20mm	19.055	
Hex 1,22mm	19.065	
Hex 1,27mm	19.110	

Recommended torque 15 Ncm 15 Ncm

DESSLoc®

88.007

CoCr BASE

6,0mm	○		30.007	30.054
6,0mm	○	Hex 1,20mm	30.007H120* 19.055	
6,0mm	○	Hex 1,22mm	30.007H122* 19.065	
6,0mm	○	Hex 1,27mm	30.007H127* 19.110	
6,0mm	○	Torx®	30.007TB* 19.306	
For welding techniques			30.107*	

CASTABLE

	○		28.007	28.054
10 Pack.	○		11.007-P10	11.054-P10



SCAN ABUTMENTS

	10 Pack.	53.153-P10
--	----------	------------



TRANSFER

		17.054
--	--	--------

DIGITAL ANALOGUE

		14.054/D
	Retention screw Hex 1,27 mm*	
	Platform Colour Coded	
	*Other retention screws available, see page 159	

ANALOGUE

		14.054
	Platform Colour Coded	
	10 Pack.	14.054-P10







BAR ATTACHMENT

		88.100
--	--	--------





RETENTION KITS

	0° - 20°	x1		DLRK-P1* DLRKL-P1
	0° - 20°	x2		DLRK-P2* DLRKL-P2
	0° - 40°	x1		DLER-P1* DLERL-P1
	0° - 40°	x2		DLER-P2* DLERL-P2

MALES

	0° - 20°	x4	1.5 lbs / 680g	DLN2-P4* DLN2L-P4
	0° - 20°	x4	3.0 lbs / 1360g	DLN3-P4* DLN3L-P4
	0° - 20°	x4	5.0 lbs / 2270g	DLN4-P4* DLN4L-P4
	0° - 40°	x4	1.5 lbs / 450g	DLN1-P4* DLN1L-P4
	0° - 40°	x4	2.0 lbs / 910g	DLN6-P4* DLN6L-P4
	0° - 40°	x4	4.0 lbs / 1810g	DLN7-P4* DLN7L-P4

SPECIAL TOOLS

	Direct to torque wrench Nobel Biocare™	DTACTLOC
	Direct to torque wrench Straumann®	DTSTRLOC
	DESSLoc® tool for square torque wrench	DTLOC
	Adaptor from Straumann® torque wrench to square connection	DTSTSQ
	Nobel Biocare™ Adapter from 8mm to square connection	DTNBSQ

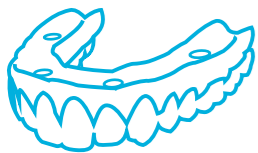

DESS CLEAN FIT

DESS CLEAN FIT

	1 x removal mechanism (includes removal pin) 3 x retentive caps	1611
	2 x removal mechanism (include removal pin) 2 x retentive caps	1611A
	2 x retentive caps	1611B
	1 x Removal pin	1611C

DESS CLEAN FIT Abutments

Fixed yet removable The best of both worlds

- Fixed restoration feel.
- Friction fit easy to remove.
- No plastic inserts.
- No bone loss.*
- periocoat® Surface treatment (DESS patented ZrN coating).
- Patented female caps with release system.
- Compatible with Atlantis® conus concept and Syncone®.



PURE SWITCH *by* DESS®
“simple switch, perfect connection”

All DESS® products are based on the “Pure Switch” philosophy, a concept which guarantees the interchangeability of abutments without having to switch tools or protocols.

This philosophy ensures that all DESS® abutments are interchangeable with any abutment of any implant brand.

- Guaranteed quality.



- Lifetime warranty¹.
- 100% compatibility.
- CAD/CAM libraries available.
- More than 30 connections from a single supplier.

HOLDERS



HLDSTD

For standard
98mm disc machines

Most industrial milling machine
with a 98mm disc holder:
Arum
Dmg
Datron
Haas
Robodril



HLDVHFR5

For VHF®

VHF® R5



HLDVHFZ4

For VHF®

VHF® Z4



HLDIMES

For Imes-Icore® machines

Coritec 150i pro
Coritec 245i touch
Coritec 250i touch
Coritec 350i / Coritec 250i Loader
Coritec 450i
Coritec 550i
Coritec 650i / Coritec 650i Loader



HLDYENA

For Yenadent®

D6
D15
D43N



HLD3R

For machines with
support / changer 3R

D14P



HLDVHF

For VHF®

VHF® S1
VHF® S2
VHF® K5
VHF® S5



HLDVHFN4

For VHF®

VHF® N4



AK-1 ROLAND

DESS premills are compatible
with AK-1 Holder, developed
and supplied by ROLAND.

AURUM MILLING TOOL



	ØA	ØB	ØC	L1	L2	L3	R
MT3D16L5	3	1,6	0,95	5	51	0,5	0,1
MT4D16L5	4	1,6	0,95	5	51	0,5	0,1
MT6D16L5	6	1,6	0,95	5	51	0,5	0,1

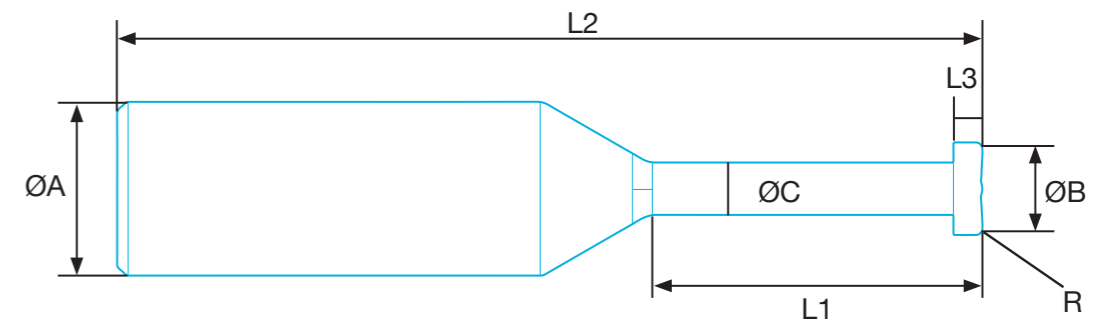

BLOCKS



Ti	□ 15mm	L 20mm	63.020
Ti	□ 15mm	L 40mm	63.040
CoCr	□ 15mm	L 20mm	73.020
CoCr	□ 15mm	L 40mm	73.040

TOOLS

SCREWDRIVERS TIPS

HEX	18mm	20mm	24mm	30mm	35mm	compatible with
0,90mm		DTC20H090	DTC24H090			Neodent® CM
1,00mm		DTC20H100	DTC24H100		DTC35H100	Dentsply Ankylos® C/X
1,20mm	DTC18H120	DTC20H120	DTC24H120	DTC30H120	DTC35H120	3i Osseotite®, Neodent® CM & GM, 3iCertain®, Megagen AnyRidge®
1,22mm		DTC20H122	DTC24H122		DTC35H122	Dentsply Friadent Xive®, Osstem® TS, GlobalD®, BTI®, Biotech Kontakt®
1,25mm		DTC20H125	DTC24H125			
1,27mm		DTC20H127	DTC24H127	DTC30H127	DTC35H127	Astra tech™, OsseosSpeed™, Zimmer Screw-Vent® & Mis® Seven/ C1 & V3, BioHorizons®, AstraTech Implants System EV™, Camlog®, Bego Semados®, Conelog®
1,30mm		DTC20H130	DTC24H130			
1,50mm		DTC20H150	DTC24H150			
1,70mm		DTC20H170	DTC24H170			
1,75mm		DTC20H175	DTC24H175			Astra tech™ EV, Uniabutment®



Torx® 06



Torx® ball



UG



UG	18mm	20mm	24mm	30mm	35mm	
		DT20U	DT24U	DT30U	DT35U	Nobel Brånemark®, NobelReplace® Select™, NobelActive™ & NobelReplace® CC, Multi-unit®



NEO 18mm 20mm 24mm 30mm 35mm compatible with



Cuadrado

1,30mm	DT20S130	DT24S130
--------	----------	----------



SCREWDRIVER HANDLES



Dentist handle

	21mm		28mm	
	Straumann® ratchet ø7mm	Nobel® ratchet ø8mm	Straumann® ratchet ø7mm	Nobel® ratchet ø8mm
HEX 1,20mm	WSDSTL21H120	WSDNBL21H120	WSDSTL28H120	WSDNBL28H120
HEX 1,25mm	WSDSTL21H125	WSDNBL21H125	WSDSTL28H125	WSDNBL28H125
UG	WSDSTL21UG	WSDNBL21UG	WSDSTL28UG	WSDNBL28UG
Torx® 06	WSDSTL21TC06	WSDNBL21TC06	WSDSTL28TC06	WSDNBL28TC06
Torx® ball	WSDSTL21TB06	WSDNBL21TB06	WSDSTL28TB06	WSDNBL28TB06

Premium laboratory handle



PHLABGOLD





PHLABBLACK

DESSLoc® Removal & Insertion Tool





PHLOC

TI-BASE EXTRACTING TOOL

	For Conelog® NP/RP	DCCON
	For Conelog® WP	DCCON50
	For ZIMMER SCREW-VENT®	DCZIM
	For Medentis ICX®	DCICX

















TORQUE WRENCH TOOL

	Type Straumann 7mm	DTSTTW
	Type Nobel 8mm	DTNBTW

TRAY MULTI-USE

	BOX1
--	------

SPECIAL TOOLS

	Multi-unit® RP	DTMURP
	Multi-unit® WP	DTMUWP
	UniAbutment® (Astra Tech osseospeed™)	DTUNI
	Octagon	DTSYN
	Torque wrench adaptor	TWADAP
	DESSLoc® Tool for square connection	DTLOC
	Adaptor from 7mm to Straumann® torque wrench to square connection	DTSTSQ
	Screwdriver tips adaptor from Straumann® torque wrench	DTSTWH
	Direct to torque wrench Nobel Biocare™ 8mm	DTACTLOC
	Direct to torque wrench Straumann® 7mm	DTSTRLOC
	Straumann® contra-angles adapter	DTSTCA
	Nobel Biocare™ adapter from 8mm to square connection	DTNBSQ
	Screwdriver tips adaptor from Nobel Biocare™ torque wrench	DTNBWH
	Nobel Biocare™ contra-angles adapter	DTNBCA
	Handpiece adaptor for Square connection	DTANGSQ
	Manual driver for Intraoral Scan abutment	DTPEI
	Manual tool for Intraoral Scan abutment	DTPEIPEEK-P2

SCREWS FOR STRUCTURES

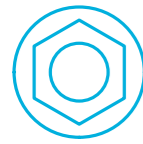

Nobel Brånemark® External Hex Universal	NP/3.5 Screw UG	For structures	19.101
			19.101-P10 <i>Pack of 10</i>

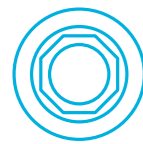

Straumann® Soft Tissue Level & SynOcta® Octagon	RN/WN Screw TORX®	For structures on implant	19.102
			19.102-P10 <i>Pack of 10</i>
Straumann® Soft Tissue Level & SynOcta® Octagon	RN/WN Screw TORX®	For structures on abutment	19.103
			19.103-P10 <i>Pack of 10</i>

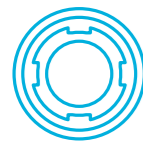

Straumann® Bone Level Conical BL	NC/RC Screw TORX®	For structures	19.104
			19.104-P10 <i>Pack of 10</i>
Straumann® Bone Level Conical BL	NC/RC Screw TORX®	For structures on Multi-Base	19.105
			19.105-P10 <i>Pack of 10</i>



MULTI-UNIT 3i	Multi-Unit connection Sxrew Hex 1,20	For 3i	19.106
			19.106-P10 <i>Pack of 10</i>

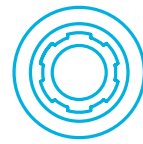

Dentsply ANKYLOS® C/X Internal ANK	Sxrew Hex 1,00	For structures on abutment	19.349
--	----------------	----------------------------	--------



MULTI-UNIT		RP/4.8 Screw Torx®	For structures	19.069-P10 <i>Pack of 10</i>
		19.269-P10 <i>DLC Pack of 10</i>		
MULTI-UNIT		RP/4.8 Hex 1,20mm	For structures	19.093-P10 <i>Pack of 10</i>
		RP/4.8 Hex 1,22mm		19.094-P10 <i>Pack of 10</i>
		RP/4.8 Hex 1,27mm		19.095-P10 <i>Pack of 10</i>
MULTI-UNIT		RP/4.8 Screw UG	For structures	19.096-P10 <i>Pack of 10</i>



DESS® DESIGN: FLAT SEAT

FLAT SEAT ADVANTAGES

- Allows for higher preload/clamping force between the structure and MUA.
- More forgiving of inaccuracies in internal milling of screw seat.
- Version with DLC coating to reduce friction and further increase preload/clamping force.
- Length of screw allows for more structure material under the screw-seat to strengthen both zirconia and temporary structures.
- Flat seat is self-centering and allows for a more forgiving alignment between diverging long-axis of the structure and MUA
- Torx connection compatible with DESS® Torx® ball screwdriver for angled screw channels.





CLINICAL SCREWS RECOMMENDED TORQUE

**NOBELACTIVE® &
NOBELREPLACE® CC**
ACTIVE HEX



PLATFORM SIZE	DESS REF. N°	DESS RECOMMENDED TORQUE (Ncm)	ORIGINAL EQUIVALENT REF. N°
3.0	19.068	15	Nobel Biocare® 36805
3.0	19.268*	15	Nobel Biocare® 37890
3.0	19.668*	15	
NP	19.027	35	Nobel Biocare® 31168
NP	19.227	35	Nobel Biocare® 29282
NP	19.101	35	
NP	19.327	35	
NP	19.627*	35	
NP ANGLEBase®	19.441	35	
RP	19.030	35	Nobel Biocare® 28815
RP	19.230	35	Nobel Biocare® 36918
RP	19.328	35	
RP	19.630*	35	
RP ANGLEBase®	19.442	35	
On1®	19.021	35	Nobel Biocare® 38751
On1®	19.221	35	Nobel Biocare® 38750
On1®	19.621*	35	
NP on implant for Multi-unit®	19.507	35	
RP on implant for Multi-unit®	19.508	35	
<hr/>			
NP	19.004	35	Nobel Biocare® 31170
NP	19.204	35	Nobel Biocare® 36818
NP	19.304	35	
NP	19.604*	35	
NP ANGLEBase®	19.404	35	
RP/WP/6.0	19.005	35	Nobel Biocare® 29293
RP/WP/6.0	19.205	35	Nobel Biocare® 29475
RP/WP/6.0	19.305	35	
RP/WP/6.0	19.605*	35	
RP/WP ANGLEBase®	19.405	35	
NP on implant for Multi-unit®	19.504	35	
RP on implant for Multi-unit®	19.505	35	

**NOBELREPLACE
SELECT™**
TRI-LOBE



NOBEL BRÅNEMARK®
EXT HEX UNIVERSAL



PLATFORM SIZE	DESS REF. N°	DESS RECOMMENDED TORQUE (Ncm)	ORIGINAL EQUIVALENT REF. N°
NP	19.027	35	Nobel Biocare® 31168
NP	19.227	35	Nobel Biocare® 29282
NP	19.327	35	
NP	19.101	35	
NP	19.627*	35	
NP ANGLEBase®	19.401	35	
RP	19.028	35	Nobel Biocare® 29290
RP	19.228	35	Nobel Biocare® 29283
RP	19.328	35	
RP	19.628*	35	
RP ANGLEBase®	19.402	35	
WP	19.029	35	Nobel Biocare® 31169
WP	19.229	35	Nobel Biocare® 29284
WP	19.329	35	
WP	19.629*	35	
NP on implant for Multi-unit®	19.501	35	
RP on implant for Multi-unit®	19.502	35	

3i CERTAIN®
EXT HEX USA



NP/RP/WP	19.034	20	Biomet 3i® UNIHT
NP/RP/WP	19.634	20	
NP/RP/WP ANGLEBase®	19.402	20	
RP on implant for Multi-unit®	19.512	20	
Low Profile® Abutment ø4.8	19.106	10	Biomet 3i® LPCTSH

3i OSSEOTITE®
INT HEX CLICK



NP/RP/WP	19.011	20	Biomet 3i® IUNIHT
NP/RP/WP	19.311	20	
NP/RP/WP	19.611	20	
NP/RP/WP ANGLEBase®	19.438	20	
Low Profile® Abutment ø4.8	19.106	10	Biomet 3i® LPCTSH

**STRAUMANN® SOFT
TISSUE LEVEL &
SynOcta®**
OCTAGON



NNC	19.070	35	Straumann® AG 048.314
NNC	19.670	35	
RN/WN on implant	19.026	35	Straumann® AG 048.356
RN/WN on implant	19.102	35	Straumann® AG 049.181
RN/WN on implant	19.328	35	
RN/WN on implant	19.626*	35	
RN/WN ANGLEBase®	19.446	35	
RN/WN on synOcta® abutment	19.009	15	Straumann® AG 048.350
RN/WN on synOcta® abutment	19.103*	15	
RN/WN on synOcta® abutment	19.609*	15	

**STRAUMANN®
BONE LEVEL**

CONICAL BL



PLATFORM SIZE	DESS REF. N°	DESS RECOMMENDED TORQUE (Ncm)	ORIGINAL EQUIVALENT REF. N°
NC on implant	19.032	35	Straumann® AG 025.2908
NC on implant	19.632*	35	
RC on implant	19.033	35	Straumann® AG 025.4908
RC on implant	19.633*	35	
NC/RC on implant	19.037	35	Straumann® AG 025.4900
NC/RC on implant	19.104	35	Straumann® AG 025.4906
NC/RC on implant	19.311	20	
NC/RC ANGLEBase®	19.443	35	
NC/RC on implant for Multi-unit®	19.544	35	
NC/RC on Multi-base® abutment	19.041	15	Straumann® AG 025.0900-04
NC/RC on Multi-base® abutment	19.105	15	
NC/RC on SRA® abutment	19.098*	15	Straumann® AG 023.4763

**STRAUMANN®
BLX**

CONICAL BLX



RB/WB	19.054	35	
RB/WB	19.700*	35	
RB/WB ANGLEBase®	19.441	35	

**NEODENT®
GRAND MORSE®**

NEO GM



GM	19.051	20	
GM ANGLEBase®	19.444	20	

**ZIMMER
SCREW-VENT®**

INT HEX USA



NP/RP/WP	19.012	30	Zimmer® URS2
NP/RP/WP	19.012L*	30	
NP/RP/WP	19.042	30	Zimmer® MHLAS
NP/RP/WP	19.642*	30	
NP/RP/WP	19.312	30	
NP/RP/WP ANGLEBase®	19.417	30	
NP (MIS®)	19.327	35	
NP on implant for Multi-unit®	19.519	30	
RP on Multi-unit® abutment ø4.8	19.110	15	
RP on Multi-unit® abutment ø4.8	19.300	15	

**ASTRA TECH
IMPLANT
SYSTEM™ EV**

CONIC EVO



PLATFORM SIZE	DESS REF. N°	DESS RECOMMENDED TORQUE (Ncm)	ORIGINAL EQUIVALENT REF. N°
3.6 on implant	19.059*	25	
3.6 on implant	19.659*	25	
3.6 ANGLEBase®	19.441	25	
4.2 on implant	19.060*	25	
4.2 on implant	19.660*	25	Astra Tech® 25.205
4.2 ANGLEBase®	19.460	25	
4.8 on implant	19.061*	25	
4.8 on implant	19.661*	25	
4.8 ANGLEBase®	19.461	25	
UniAbutment® EV	19.058	15	
UniAbutment® EV	19.658*	15	

**ASTRA TECH
OSSEOSPEED™**

INT HEX CONIC



NP on implant	19.015	15	Dentsply® 24189
NP on implant	19.615*	15	
RP on implant	19.016	20	Dentsply® 24449
RP on implant	19.616*	20	
RP ANGLEBase®	19.441	20	
WP on implant	19.017	25	Dentsply® 24209
WP on implant	19.617*	25	
WP ANGLEBase®	19.425	25	
UniAbutment® 20°/45°	19.018	15	Dentsply® 22435
UniAbutment® 20°/45°	19.618*	15	

**DENTSPLY
FRIADENT XIVE®**

INT HEX FD







NP/RP/WP	19.024	24	Dentsply® 454305
NP/RP/WP	19.624*	24	
NP/RP/WP ANGLEBase®	19.438	24	





**DENTSPLY
ANKYLOS® C/X**

INT ANK





All platforms	19.048	15	
All platforms	19.050	15	
All platforms	19.648*	15	

	PLATFORM SIZE	DESS REF. N°	DESS RECOMMENDED TORQUE (Ncm)	ORIGINAL EQUIVALENT REF. N°
OSSTEM® TS CONIC OSS 	Mini on implant	19.072	20	
	Mini on implant	19.672*	20	
	Mini ANGLEBase®	19.444	20	
	Standard on implant	19.073	30	Osstem® GSABSST
	Standard on implant	19.673*	30	
	Standard ANGLEBase®	19.461	30	
CAMLOG® INT CAM 	3,3 / 3,8 / 4,3 on implant	19.044	20	
	3,3 / 3,8 / 4,3 on implant	19.644*	20	Camlog® J4005. 1601
	3,8 / 4,3 ANGLEBase®	19.444	20	
	5.0 on implant	19.045	20	Camlog® J4005. 2001
	5.0 on implant	19.645*	20	
CONELOG® INT CON 	3,3 / 3,8 / 4,3 on implant	19.074*	20	Camlog® C4005. 1601
	3,3 / 3,8 / 4,3 on implant	19.674*	20	
	5.0 on implant	19.076*	20	Camlog® C4005. 2001
	5.0 on implant	19.676*	20	
BIOHORIZONS® INTERNAL INT HEX BH 	On implant	19.043	30	BioHorizons® PXAS
	On implant	19.043	30	
	Multi-unit® RP ø4.8	19.006	15	Nobel Biocare® 29287
	Low Profile® abutment ø4.8	19.106	10	Biomet 3i® LPCTSH
	Multi-unit® RP ø4.8	19.110	15	
	Multi-unit® RP ø4.8	19.206	15	Nobel Biocare® 29285
	Multi-unit® RP ø4.8 ANGLEBase®	19.306	15	
	Multi-unit® RP ø4.8	19.606*	15	
	MIS® Multi-unit® RP ø4.8	19.300	15	
	Multi-unit® WP ø6.0	19.031	15	Nobel Biocare® 31163
	Multi-unit® WP ø6.0	19.231	15	Nobel Biocare® 29286
	Multi-unit® WP ø6.0 ANGLEBase®	19.331*	15	
	Multi-unit® WP ø6.0	19.631*	15	

	PLATFORM SIZE	DESS REF. N°	DESS RECOMMENDED TORQUE (Ncm)	ORIGINAL EQUIVALENT REF. N°
BIOHORIZONS® EXTERNAL EXT HEX BH 	NP	19.013*	30	BioHorizons® 130-050
	NP	19.312	30	
	RP/WP	19.014*	30	BioHorizons® 140-050
	RP/WP	19.328	35	
MIS® SEVEN INT HEX MI 	NP	19.056*	30	
	NP	19.656*	30	MIS® MN-S0160
	SP/WP	19.081*	30	MIS® MD-S0220
	SP/WP	19.681*	30	
	SP/WP ANGLEBase®	19.417	30	
	Multi-unit® MIS®	19.085*	25	
	Multi-unit® MIS®	19.685*	25	MIS® MU-S0220
MIS® C1 CONIC MC 	NP	19.056*	30	
	NP	19.656*	30	MIS® MN-S0160
	SP/WP	19.081*	30	MIS® MD-S0220
	SP/WP	19.681*	30	
	Multi-unit® MIS®	19.085*	25	
	Multi-unit® MIS®	19.685*	25	MIS® MU-S0220
MIS® V3 CONIC MV 	NP	19.056*	30	
	NP	19.656*	30	MIS® MN-S0160
	SP	19.081*	30	MIS® MD-S0220
	SP	19.681*	30	
	Multi-unit® MIS®	19.085*	25	
	Multi-unit® MIS®	19.685*	25	MIS® MU-S0220
MEGAGEN AnyRidge® CONIC ANYR 	All platforms	19.057	35	
	All platforms	19.657*	35	Megagen® AANMSF
	All platforms ANGLEBase®	19.460	35	

	PLATFORM SIZE	DESS REF. N°	DESS RECOMMENDED TORQUE (Ncm)	ORIGINAL EQUIVALENT REF. N°
Anthogyr AXIOM® BL CONIC AXIO 	On implant	19.077*	25	Anthogyr® OPTS161
	On implant	19.677*	25	
	Multi-unit® abutment	19.062*	15	
	Multi-unit® abutment	19.662*	15	

MEDENTIS ICX® CONIC IC 	On implant	19.080*	30	Medentis® C-007-000001-01
	On implant	19.680*	30	
	On implant ANGLEBase® H2.2	19.444	30	
	On implant ANGLEBase® H0.9	19.443	30	

GLOBALD IN-KONE® CONIC INK 	On implant	19.086*	15	GlobalD® DVPCI
	On implant	19.686*	15	
	Conical abutment Straight	19.035*	15	GlobalD® DVPIINK
	Conical abutment Straight	19.635*	15	
	Conical abutment angled	19.036*	15	
	Conical abutment angled	19.636*	15	

DENTIUM SUPERLINE™ & IMPLANTIUM® CONIC DENT 	On implant	19.090*	30	Dentium® ASC 2045
	On implant	19.690*	30	
	On abutment	19.066*	10	Dentium® SRS 18T
	On abutment	19.666*	10	

BEGO SEMADOS® INTERNAL SEM 	On implant	19.091*	30	Bego® 57.031
	On implant	19.691*	30	

	PLATFORM SIZE	DESS REF. N°	DESS RECOMMENDED TORQUE (Ncm)	ORIGINAL EQUIVALENT REF. N°
BIOTECH KONTACT® CONIC BIO 	On implant	19.078*	20	Biotech® KVP
	On implant	19.678*	20	
	Conical abutment Narrow	19.063*	20	
	Conical abutment Narrow	19.663*	20	
	Conical abutment Standard	19.064*	20	Biotech® KECGMV
	Conical abutment Standard	19.664*	20	

BTI® INTERNAL BT 	On implant	19.079*	35	
	On implant	19.679*	35	
	Multi IM®	19.065	10	
	Multi IM®	19.665*	10	

PHIBO® TSH® EXTERNAL HEX PH 	NP ANGLEBase®	19.403*	35	
	SP/WP ANGLEBase®	19.402	35	

	PLATFORM SIZE	DESS REF. N°	DESS RECOMMENDED TORQUE (Ncm)	ORIGINAL EQUIVALENT REF. N°
MULTI-UNIT 	NP	19.006	15	
	NP	19.206	15	
	NP	19.606*	15	
	WP	19.031	15	
	WP	19.231	15	
	WP	19.631*	15	
	RP ANGLEBase®	19.306	15	
	WP ANGLEBase®	19.631*	15	

LOCK SCREWS FOR DIGITAL ANALOGUE



HEX 1,00	19.707-P5	HEX 1,28	19.713-P5
HEX 1,18	19.708-P5	HEX 1,40	19.714-P5
HEX 1,20	19.709-P5	Unigrip®	19.715-P5
HEX 1,22	19.710-P5	Torx®	19.716-P5
HEX 1,25	19.711-P5	NE	19.717-P5
HEX 1,27	19.712-P5		



 **DESS**
- DENTAL SMART SOLUTIONS



All DESS products are manufactured according to ISO 9001 and ISO 13485 with CE marking for all products Class IIb IIa

All DESS® ANGLEBase® screws and screwdrivers are based on the standard ISO 10664
3i® and 3i Certain®, Miniplant®, MicroMiniplant™ and Osseotite® are registered trademarks of 3i Implant Innovations, USA

ASTRA TECH™, OsseoSpeed™, ANKYLOS® C/X, XiVE®, FRIADENT®, ASTRATECH implant system™ EV and UniAbutment®

Cerec® are registered trademarks of DENTSPLY SIRONA Implants

BioHorizons® is a registered trademark of BioHorizons, INC.

Brånemark System®, NobelReplace® and Replace Select™, NobelActive™, NobelReplace® CC, NobelSpeedy™ and Multi-unit® are registered trademarks of Nobel Biocare AB,

Neodent®, Grand Morse®, Straumann® and synOcta® are registered trademarks of Straumann Holding AG, Switzerland

MIS® is a registered trademark of MIS Implant Technologies Ltd.

Zimmer Screw-Vent® and SwissPlus® are registered trademarks of Zimmer Dental INC, USA

Dyna® is a registered trademark of Dyna Dental Engineering BV

Locator® is a registered trademark of ZEST IP Holdings

Camlog® and Conelog® are registered trademarks of CAMLOG Biotechnologies AG

Megagen® is a registered trademark of MEGAGEN IMPLANT CO. LTD

TORX® is a trademark of ACUMENT INTELLECTUAL PROPERTIES, LLC

Bego Semados® is a registered trademark of BEGO GmbH & Co. KG

Anthogyr® is a registered trademark of Anthogyr SAS

Medentis ICX® is a registered trademark of medentis medical GmbH

Osstem®, Hiossen® is a registered trademark of OSSTEM IMPLANT CO. LTD

Dentium® is a trademark of Dentium Co. Ltd.

GOBALD® is a trademark of Global D SASU.

Biotech Kontakt® is a trademark Biotech Dental SAS.

BTI® is a trademark BTI Biotechnology Institute.

PHIBO® is a trademark PHIBO Dental Solutions S.L.

DESS products can be used only by licensed dentists, physicians and labs.

Please refer ever to the instructions for use available on the website

www.dessdental.com

or supplied with the product.

Some products may not be available in your country. Some of the products are cleared for US and Canada.

Please contact your local distributor for more details.



Health Canada
Medical Device Licenses
94512 & 107023





www.dessdental.com